

CG *SERIES*®

PORTABLE CHILLER

Covering models from 5 to 40 tons with CG Instrument & Scroll Compressors



TEMPTEK, INC.

525 East Stop 18 Road Greenwood, IN 46142

317-887-6352 fax: 317-881-1277

Service Department fax: 317-885-8683

www.TempTek.com

E-mail: sales@TempTek.com

Model: _____

Serial Number : _____



INSTRUCTION MANUAL
With **CG INSTRUMENT**
& **SCROLL COMPRESSORS**
AIR & WATER-COOLED MODELS

COVERING

INSTALLATION
OPERATION
MAINTENANCE



TEMPTEK, INC. 525 East Stop 18 Road Greenwood, IN 46142
Phone: 317-887-6352 fax: 317-881-1277 Service Department fax: 317-885-8683
www.TempTek.com E-mail: sales@TempTek.com

TABLE OF CONTENTS

1.0 GENERAL	7
1.1 Introduction	8
1.2 Safety	8
1.3 Receiving instructions	9
1.4 Efficiency	9
1.5 Clean air act	9
1.6 Water Treatment	10
1.7 Components	10
2.0 INSTALLATION	13
2.1 General	14
2.2 To and From process connections	14
2.3 Water supply connection	15
2.4 Water make-up supply connection	16
2.5 Air-cooled condenser	16
2.6 Water-cooled condenser	18
2.7 Electrical connection	18
3.0 OPERATIONS	21
3.1 General	22
3.2 Start up/operations procedure	22
3.3 Instrument : Start Up & Operation	30
3.4 Instrument : Main Menu	34
3.5 Instrument : Setpoints Menu	34
3.6 Instrument : Utilities Menu	36
3.7 Instrument : Network Menu	37
3.8 Instrument : Flow Menu (optional)	38
3.9 Instrument : Options Menu	39
3.10 Instrument : Machine Menu	40
3.11 Low tank level	43
3.12 Shut down procedure	44
4.0 TROUBLESHOOTING	45
4.1 Unit Will Not Start	46
4.2 Compressor Hums But Will Not Start	46
4.3 Shuts Off On High Pressure	46
4.4 Shuts Off On Low Pressure	47
4.5 Compressor Shuts Off On Internal Overload	48
4.6 Low Or No Process Pressure Or Water Flow	48
4.7 Cooling Capacity Inadequate	49
4.8 Sensor	49
4.9 Coolant Pump	49
4.10 Chiller Controller	49
4.11 Replacement Controller Configuration	51



5.0	MAINTENANCE	53
5.1	Warranty service procedure	54
5.2	Periodic preventative maintenance	54
5.3	Special maintenance	55
5.4	Automatic water make-up service	56
5.5	Pump seal service	58
5.6	Checking the refrigerant charge	61
5.7	Proper cleaning procedure for brazed plate evaporators	61
6.0	COMPONENTS	63
6.1	Water system	64
6.2	Refrigeration system	64
6.3	Options	65
7.0	RELATED DRAWINGS	67
7.1	Mechanical Schematic : Water-Cooled : 5 - 10 Tons	68
7.2	Mechanical Schematic : Water-Cooled : 15 - 40 Tons	69
7.3	Mechanical Schematic : Air-Cooled : 5 - 10 Tons	70
7.4	Mechanical Schematic : Air-Cooled : 15 - 30 Tons	71
7.5	Electrical Drawing : Air-Cooled	72
7.6	Electrical Drawing : Water-Cooled	73
7.7	Physical : Water-Cooled : 5 - 10 Ton	74
7.8	Duct Schematic for Air-Cooled Chillers	75
8.0	APPENDIX	77
8.1	Operations below 48°F fluid or 38°F ambient	78
8.2	Refrigerant pressure-temperature chart	79
8.3	Inhibited propylene glycol	80
8.4	Chiller capacity and derate chart	80
8.5	Standard CG Instrument Settings	81
8.6	Probe Calibration : CG Instrument	82
8.7	Status Indicators : CG Instrument	84
8.8	Water Quality	85
8.9	Modbus Registers	87



THIS PAGE INTENTIONALLY BLANK

1.0 GENERAL

- 1.1** Introduction
- 1.2** Safety
- 1.3** Receiving Instructions
- 1.4** Efficiency
- 1.5** Clean Air Act
- 1.6** Miscellaneous
- 1.7** Water Treatment
- 1.8** Components



1.1 INTRODUCTION

- A. This manual covers portable chillers from 5 to 40 tons (17 to 140 kW) of cooling capacity using the CG microprocessor control instrument, fixed displacement scroll compressors and digital scroll compressors. The standard fluid operating temperature range for this chiller is 20°F to 80°F for units using R410A refrigerant. Units using other refrigerants have different standard operating ranges. Units operating below 48°F fluid require the use of an inhibited industrial grade propylene glycol/water mixture to prevent freezing. Customized units may have different operating ranges. Consult the factory if you have questions about the operating range of your chiller.
- B. The intent of this manual is to serve as a guide in the installation, operation and maintenance of your chiller. Improper installation can lead to equipment damage and poor performance. Failure to follow the installation, operation and maintenance instructions may result in damage to the unit that is not covered under the limited warranty. This manual is for standard products. The information contained in this manual is intended to be general in nature. The information is typical only and may not represent the actual unit purchased.
- C. Chemical refrigerants are used in this unit. The refrigerant is sealed and tested in a pressurized system however a system failure will release it. Refrigerant gas can cause toxic fumes if exposed to fire. Install this unit in a well-ventilated area away from open flames. Failure to follow these instructions may result in a hazardous condition. Recover refrigerant to relieve pressure before opening the system. See nameplate for refrigerant type. Do not use non-approved refrigerants or refrigerant substitutes.
- D. Customers should implement a refrigerant management program to document the type and quantity of refrigerant in each chiller. All refrigeration service technicians performing work on this chiller must be licensed and certified.
- E. When calling for assistance from the Manufacturer's Service Department, it is important to know the model and serial number of the particular unit. The model number includes critical unit information which is helpful when troubleshooting operating difficulties. The serial number allows the service team to locate manufacturing and testing records which can have additional information relating to a particular unit.

1.2 SAFETY

- A. It is important to become thoroughly familiar with this manual and the operating characteristics of the unit.
- B. It is the owner's responsibility to ensure proper operator training, installation, operation, and maintenance of the unit.
- C. Observe all warning and safety placards applied to the chiller. Failure to observe all warnings can result in serious injury or death to the operator and severe mechanical damage to the unit.
- D. Observe all safety precautions during installation, startup and service of this equipment due to the presence of high voltage and refrigerant charge. Only qualified personnel should install, startup and service this equipment.





WARNING: This equipment contains hazardous voltages that can cause severe injury or death. Disconnect and lock out incoming power before installing or servicing the equipment.



WARNING: This equipment contains refrigerant under pressure. Accidental release of refrigerant under pressure can cause personal injury and or property damage. Exercise care while working on or around this equipment.



WARNING: Vent all refrigerant relief valves in accordance to ANSI/ASHRAE Standard 15, Safety Code for Mechanical Refrigeration. This equipment should be located within a well-ventilated area. Inhalation of refrigerant can be hazardous to your health and the accumulation of refrigerant within an enclosed space can displace oxygen and cause suffocation.

E. When working on this equipment, observe precautions in manual, literature, on tags, stickers and labels located on the equipment. Wear work gloves and safety glasses.

F. **Samples of Warning Labels applied to typical chillers.**

- Alerts users to the danger of high voltage.



- Alerts user to the danger of the rotating condenser fans on air condensed units.



- Alerts user to the danger of belt drive systems on unit with blowers.



- Alerts users to the danger of the refrigeration system under pressure. This symbol is seen on all chillers. System should only be serviced by a licensed technician.



1.3 RECEIVING INSTRUCTIONS

- A. Chillers are shipped skid mounted and wrapped in plastic prior to shipment. Check the overall condition of the equipment prior to accepting delivery.
- B. Check for visible damage and document any evident damage on the delivery receipt. This unit has digital gauges. To check the refrigerant pressure to be certain the system charge is intact power must be applied to the unit. See the chart in section 8.2 for proper pressure readings based on the ambient temperature and refrigerant type used in the chiller. Shipping damage is the responsibility of the carrier.
- C. In order to expedite payment for damages, should they occur, follow proper damaged freight claim filing procedures with the carrier and keep detailed records. Take photographs of any suspected damage.

1.4 EFFICIENCY

- A. Long term efficiency of operation is largely determined by proper maintenance of the mechanical parts of the unit and the water quality. The Manufacturer recommends filtering the process water to prevent solids from plugging critical parts. The Manufacturer highly recommends that the services of a qualified water treatment specialist be obtained and their recommendations be followed. The Manufacturer accepts no responsibility for inefficient operation, damage caused by foreign materials or failure to use adequate water treatment.

1.5 CLEAN AIR ACT



WARNING: Vent all refrigerant relief valves in accordance to ANSI/ASHRAE Standard 15, Safety Code for Mechanical Refrigeration. This equipment should be located within a well-ventilated area. Inhalation of refrigerant can be hazardous to your health and the accumulation of refrigerant within an enclosed space can displace oxygen and cause suffocation.

- A. Units manufactured after January 1, 2010 may contain refrigerant HFC-410A, HFC-407C, HFC-404A or HFC-134A. Most units manufactured prior to January 1, 2010 contain refrigerant HCFC-22.
- B. It is unlawful for any person in the course of maintaining, servicing, repairing, or disposing of refrigeration equipment to knowingly vent or otherwise dispose of any substance used as a refrigerant in the manner which permits such substance to enter the atmosphere.
- C. Very small releases associated with good faith attempts to recapture, reclaim or recycle such substance shall not be subject to the prohibition set forth in the preceding paragraph.
- D. Customers should implement a refrigerant management program to document the type and quantity of refrigerant in each chiller. All refrigeration service technicians performing work on this chiller must be licensed and certified.
- E. Vent all refrigerant relief valves in accordance to ANSI/ASHRAE Standard 15.

1.6 WATER TREATMENT



WARNING: Improper water treatment will void unit warranty.

- A. The use of untreated or improperly treated water in a portable chiller may result in scaling, erosion, corrosion, algae or slime.
- B. It is recommended that the services of a qualified water treatment specialist be engaged to determine what water treatment is required.
- C. The Manufacturer assumes no responsibility for equipment failures which result from untreated or improperly treated water.
- D. Do not use straight deionized or RO (reverse osmosis) water in this unit. Some customized units may be compatible with deionized or RO water. Consult the factory before using deionized or RO water.

1.7 COMPONENTS



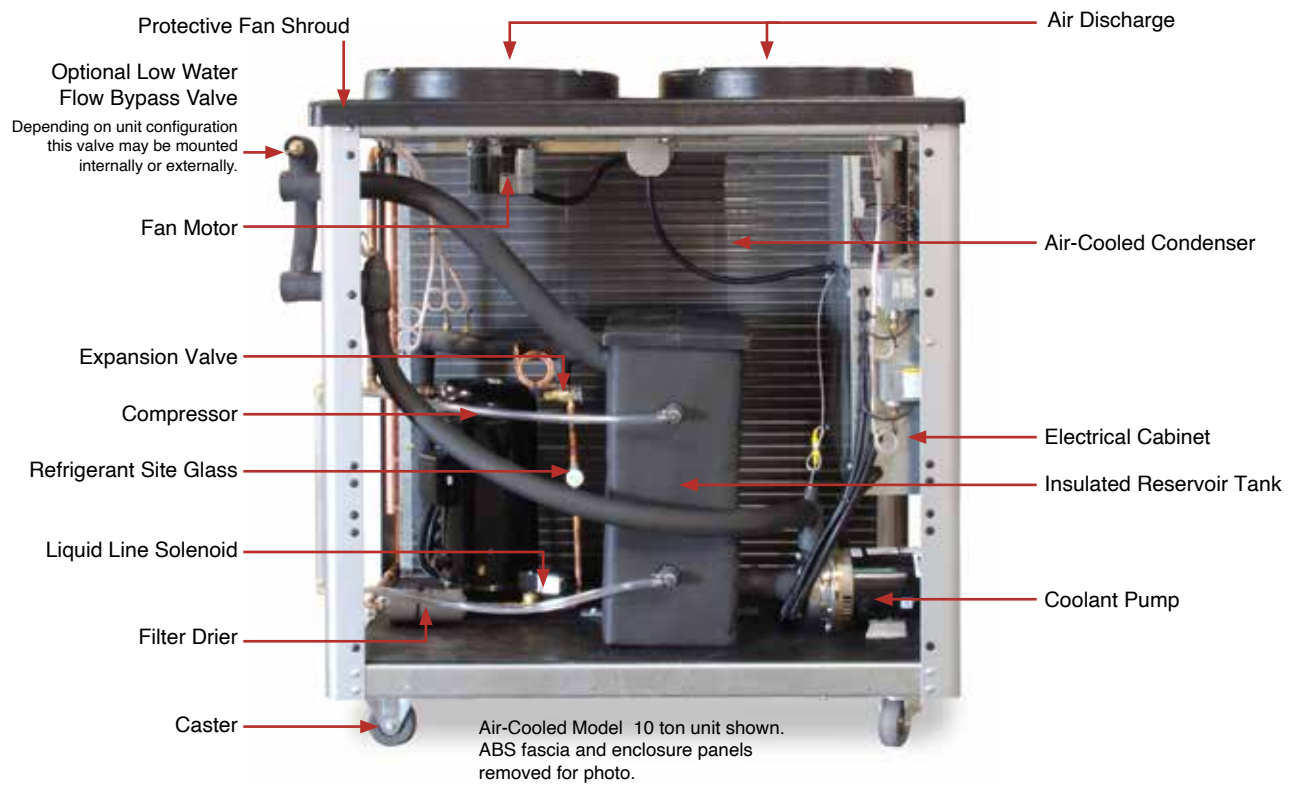

2.0 INSTALLATION

- 2.1** General
- 2.2** Unit Location
- 2.3** To and From Process Connections
- 2.4** Make-Up Water Supply Connection
- 2.5** Air-Cooled Condenser Installation
- 2.6** Water-Cooled Condenser Installation
- 2.7** Electrical Connection



2.1 GENERAL

- A. Chillers are shipped skid mounted and wrapped in plastic prior to shipment. Check the overall condition of the equipment prior to accepting delivery. Check for visible damage and document any evident damage on the delivery receipt. Shipping damage is the responsibility of the carrier.
- B. All process piping materials (such as hose, rigid piping, valves or filters) used in process water piping circuitry must be rated for 100°F minimum temperature and 70 PSI minimum pressure. Some customized units may operate at water pressures above 70 psi. Use appropriate piping materials.
- C. All such materials must have the equivalent or larger diameter of the particular process connection that length of process water piping is connected to.

2.2 UNIT LOCATION

- A. **Foundation.** The chiller must be installed on a rigid and level mounting surface with adequate strength to support the operating weight of the chiller including the weight of water and attached piping.

This unit will contain water or water/glycol when operating. Locate the chiller where an unforeseen fluid leak will not cause damage to the surroundings or install the unit in such a way that an unforeseen fluid leak will not damage its surroundings.

- B. For air-cooled and water-cooled models:
 - 1. These units are designed for indoor use only.
 - 2. For most efficient operation, locate the chiller in a level, clean, dry and well ventilated environment.
- C. **For air-cooled models:**
 - 1. The unit has an air-cooled refrigerant condenser. For air-cooled condensers, a motor driven propeller fan (on models from 5 to 20 tons) or a centrifugal blower (standard on models from 25 to 30 tons and optional on other models) generates air flow through the condenser to remove heat from the refrigerant system. The air cooled condenser on the unit will discharge approximately 15,000 BTU's per hour per ton of cooling and the air flow rate is approximately 1,000 cfm / nominal ton.
 - 2. The unit must have a minimum entering air temperature of 60°F and a maximum entering air temperature of 95°F for efficient operation.
 - 3. The unit must have a minimum of two feet clearance at the air intake and six feet at the vertical exhaust air discharge and must have adequate ventilation to dissipate the rejected heat. The unit must not be placed in non-ventilated areas.
 - 4. The unit must have all enclosure panels in place before operating the



compressor. Air will not be drawn through the condenser coil if the panels are not in place. Starting the unit without all the enclosure panels in place will result in a high pressure refrigerant fault.

5. Units with a motor-driven propeller fan may not use duct work unless a booster fan of equal volume rating has been installed in the duct.

2.3 TO AND FROM PROCESS CONNECTIONS

- A. Use appropriately rated hose or fluid piping to connect the process piping going to your process to the “to process” connection on the chiller.
- B. Use appropriately rated hose or fluid piping to connect the process piping coming back from your process to the “from process” connection on the chiller.
- C. Install a high volume basket strainer in the From Process line with isolation valves. A basket strainer or bag filter with a mesh screen of 20-40 microns will protect the unit. **A “wye” type strainer is not recommended because it does not have adequate debris holding capacity.**
- D. Process water piping should be designed to avoid excessive elbows and/or lengths of pipe or hose. If using flexible hose avoid tight twists or curls and excessive lengths.
- E. Valves and filters may be installed in the process water piping to facilitate service and maintenance provided that such devices maintain the full inside diameter of the process connection. If installed, all such devices must be open and clean during unit operation.
- F. It is important to check all external process connections for leaks prior to starting the unit. It is also important to check external connections, internal hose clamps and fitting connections for leaks after servicing the unit.

To Process

This label marks the To Process connection

From Process

This label marks the From Process connection



Typical wye strainer - Not recommended.

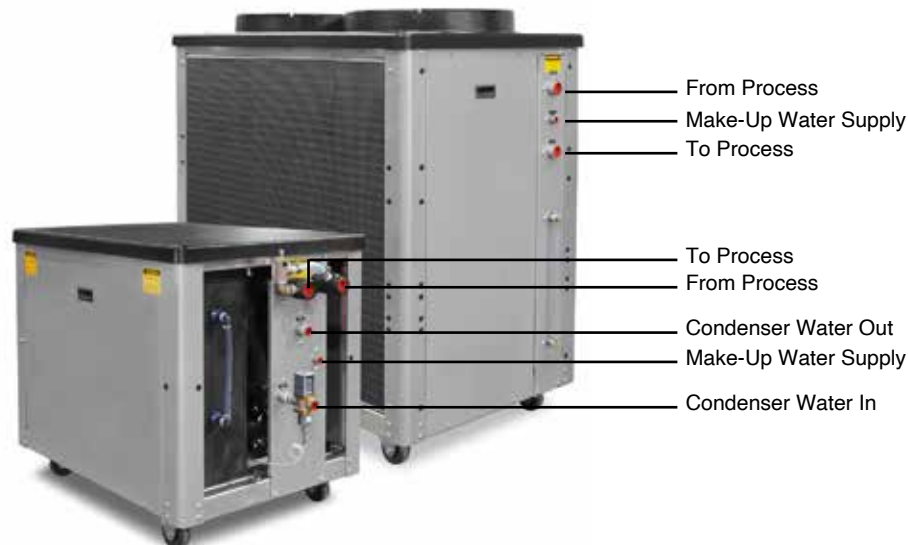



WARNING: Check local codes to determine proper use of back flow prevention device in water make-up supply line.

2.4 MAKE-UP WATER SUPPLY CONNECTION

A. The automatic water make-up system continually monitors the reservoir tank and fills it when needed. Connect as follows:

Water Make-up

This label marks the Water Make-up connection

1. Using appropriately rated hose or fluid piping connect the “water make-up” connection to the plant’s water source.
2. Minimum make-up water supply pressure is normally 20 psi.
3. Install an owner supplied shut off valve in the make-up water supply line. Install this valve on the outside of the unit.
4. Use a back flow prevention device as required by local codes to prevent possible contamination of potable water.

B. Do not use automatic water make-up system when operating with glycol below 48°F.

2.5 AIR COOLED CONDENSER

A. Air-cooled condensers require ambient air temperatures between 60°F and 95°F for efficient operation. Operating above 95°F may result in elevated condensing pressures and eventual shut-down on the high pressure limit switch. Air temperatures below 60°F may result in over condensing pressures and cause a low pressure refrigerant fault. Consult with the Manufacturer’s service department for more information on operating with ambients air temperatures above 95°F or below 60°F.

B. Air flow is generated by the motor mounted propeller fan(s) or centrifugal blower(s). Air flow is from the outside of the chiller, through the condenser and exhausted through the top of the unit. On centrifugal blowers models, exhaust air can be ducted outside of the plant’s interior environment. Special duct work is required and a HVAC contractor should be consulted for sizing and material specifications. Exhaust air can not be ducted on propeller fan models.

C. A free air space of at least four (4) feet is required at the condenser intake and six (6) feet at the condenser discharge to allow for proper air flow.

D. At full load, the chiller will discharge approximately 15,000 BTU’s per hour per ton of cooling.

E. On centrifugal blower units, air discharge duct work should be sized by a qualified HVAC engineer. Sizing shall be according to rated CFM at the static pressure of .90 inches of water. See figure at right.

CFM RATINGS

Model	CFM
5 Tons	5,000
7.5 Tons	7,500
10 Tons	10,000
15 Tons	15,000
20 Tons	20,000
25 Tons	25,000
30 Tons	30,000





WARNING: Do not attempt to duct exhaust air from a portable chiller using motor driven fans. Exhaust air can only be ducted from a portable chiller using a centrifugal blower assembly.

- F. All air cooled units **MUST** have all enclosure panels in place before operating the compressor. Air will not be drawn through the condenser coil if the panels are not in place. Starting the unit without the enclosure panels in place will result in a refrigerant fault.
- G. **Condenser Air Filtering.** Use a filter that produces very low air flow restrictions. Generally a disposable fiberglass filter with a MERV rating of 2 - 3 provides adequate air filtration. The purpose of the filter is to prevent large particles such as dust, lint and debris from fouling the condenser. You should be able to see through the filter media. Using restrictive filter media can cause loss of chiller capacity, difficulty running in warm weather and fan motor overheating.



Typical Filter shown on 10 ton air-cooled unit.



WARNING: Do not attempt to start or operate an air-cooled portable chiller without all cabinetry panels in place. Air-cooled chillers require air to be drawn through the air-cooled condenser. This will not occur if the panels are not in place.

2.6 WATER-COOLED CONDENSER

- A.** Connect the facility cooling tower or city water supply to the “condenser water in” connection on the unit.

1. Required flow rate from a city water source at 65°F is 1.5 gpm/ton of rated capacity.
2. Required flow rate from a tower water source at 85°F is 3 gpm/ton of rated capacity.

Condenser
Water In

This label marks the
Condenser Water In
connection

- B.** Connect the facility tower system return or drain to the “condenser water out” connection on the unit.

1. **Note:** Follow all local codes and regulations when dumping to the plant’s sanitary or other drain.

Condenser
Water Out

This label marks the
Condenser Water Out
connection

- C.** The pressure differential requirement between the condenser “water in” and the condenser “water out” lines must be 30 psi minimum.

- D.** The installation of a strainer in the condenser “water in” line is recommended. This removes solids from the water supply and serves to protect the water saver (regulator) valve.

- E.** The water regulator valve is normally factory set for proper operation. When field adjustments are required, turn the adjusting nut on the top of the valve counter clockwise to raise the refrigerant pressure and clockwise to lower the pressure. Adjustments should be made only when the chiller is running at full load.



Typical water saver regulator valve.

2.7 ELECTRICAL CONNECTION



WARNING: Do not connect the unit to a voltage supply not equal to the unit’s voltage requirements as specified on the unit’s data plate. Use of incorrect voltage will void the unit’s warranty and cause a significant hazard that may result in serious personal injury and unit damage.



WARNING: Electric Shock Hazard. High Voltage is present in the electrical cabinet. Disconnect power before servicing. Follow all facility lock-out/tag-out procedures.

A. STANDARD MODELS

1. All electrical wiring must comply with local codes and the National Electric Code.

2. Electrical power supply requirements for standard units are identified on the equipment data tag. Determine that the plant's voltage supply is the same as the unit's voltage requirements, taking into account the SSCR Rating.
3. A customer supplied, four conductor cable is required for connection to a customer supplied fused disconnecting means. The fused disconnecting means shall be sized and installed according to the unit's power supply requirements and local electrical codes. (Some custom units may include a fused or non-fused disconnect switch. "Fused" may be fuses on circuit breaker.)
4. Connect the four conductor power cable to the power entry terminal block on the unit's electrical panel. Then connect the power cable to the fused disconnect switch. There is no power entry hole into the electrical cabinet. This allows the matching of the entry hole size and location to the customer supplied fittings.
5. A unit specific electrical drawing is shipped with the unit.
6. Voltage supplies must be within +/- 10% of the name plate voltage and must be within 2% from leg to leg. Extreme voltage imbalance or using the wrong voltage can damage your chiller and cause premature unit failure as well as a safety risk.
7. A proper ground is required for the unit.



Typical data tag.

B. CONTROL CIRCUIT WIRING

1. The unit's supplied control circuit is 115 volt, 1 phase, 60 cycle. Certain international voltage models will have 110 volt 1 phase 50 cycles control voltage.
2. The control circuit is supplied by the factory installed transformer. A control circuit fuse is provided.

C. GENERAL

1. Make certain all ground connections to the unit are properly affixed.
2. Make certain power conductor, disconnecting means, and fusing are properly sized according to the unit's power supply requirements.
3. Follow all local and national codes.
4. Make certain that all owner and factory wire connections are tight before applying power to the unit.



WARNING: Check that all owner and factory electrical connections are tight before starting. Disconnect power before servicing. Follow all facility lock-out tag-out procedures.



Electrical Cabinet

Electrical Cabinet

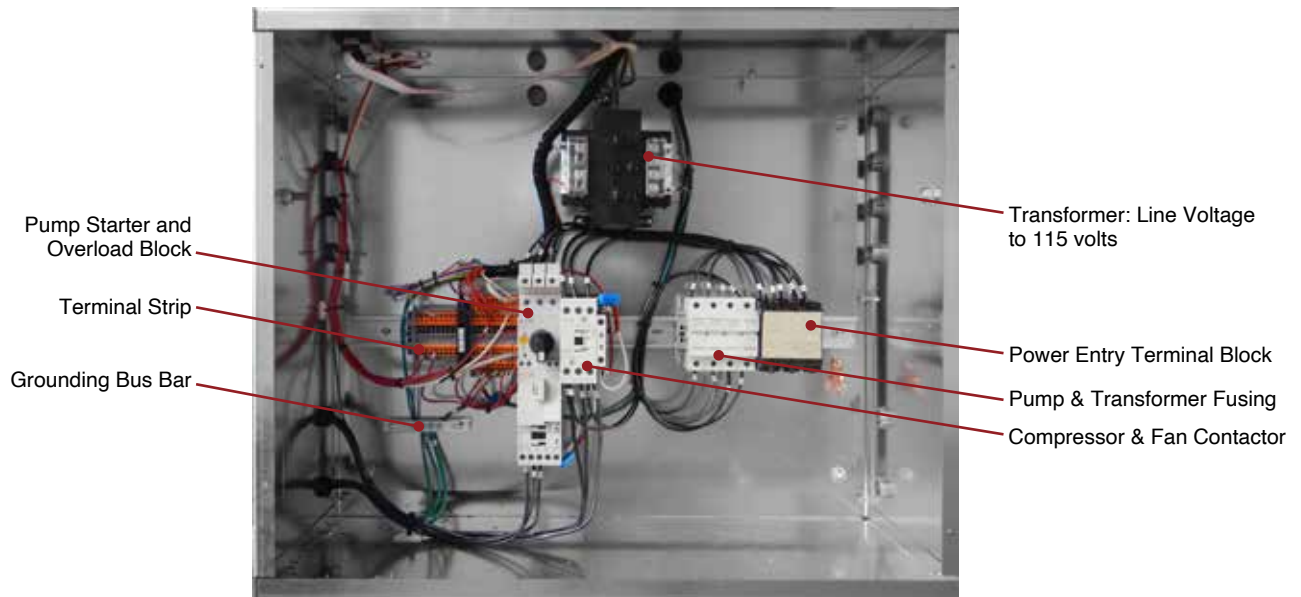

Typical electrical panel.



3.0 OPERATIONS

- 3.1** General
- 3.2** Start Up/Operations Procedure
- 3.3** Instrument : Operation
- 3.4** Instrument : Main Menu
- 3.5** Instrument : Setpoints Menu
- 3.6** Instrument : Utilities Menu
- 3.7** Instrument : Network Menu
- 3.8** Instrument : Flow Menu (optional)
- 3.9** Instrument : Options Menu
- 3.10** Instrument : Machine Menu
- 3.11** Low Tank Level
- 3.12** Shut Down



3.1 GENERAL

- A. Failure to follow the factory required operations procedure may adversely affect the unit's ability to adequately control process temperature and may create a hazardous operating condition which may result in serious operator injury and/or unit damage.



WARNING: Follow all Factory operations procedures. Failure to do so may create a hazardous operating condition which may result in serious operator injury and/or unit damage.

- B. The OPERATIONS segment of this manual is divided into the following sections:

- 3.2 Start up/operations** - follow this segment to start the unit after the initial installation to the process system or to restart the unit after reinstallation to the same or different process system. This section includes information on system fill, electric motor phasing (motor rotation) and process flow adjustments.
- 3.3 Chiller Control** - follow this segment to start up and operate the chiller control. This section includes information on setpoint selection and adjustment, and feature explanations.
- 3.4 Shut down procedure** - follow this segment to shut down the unit. This segment includes information on system shut down, electrical power supply precautions, and disconnection from system.

3.2 START UP / OPERATION PROCEDURE

A. **System Fill**

1. For operating temperatures from 48°F to 80°F use water to fill the unit.

For operating temperatures below 48°F a water and propylene glycol mixture must be used. An inhibited propylene glycol can be used for operating temperatures above 48°F if desired to prevent corrosion and scaling. Use the minimum ratio that is recommended by the glycol manufacturer. See section 8 of this manual for more information.



NOTICE: See Section 8 of this Manual if using a water & glycol fluid mixture.

2. The unit has an internal reservoir which must be filled and maintained for proper operation. The unit has a level switch mounted at the proper water level in the reservoir. Some units are customized to draw water from an owner supplied external reservoir and will not have an internal reservoir. These units will normally have an "R" in the model number. Example: CGD-10AR and are referred to as "reverse flow". See Section 6.3.H for more information.

Please note, Sections 3.2.A & 5.4 are not applicable for reverse flow units.

3. **WATER QUALITY CONTROL.** Lack of, as well as, improper water treatment can damage the chilling unit. The services of competent water treatment specialist should be obtained and their recommendations followed. It is the equipment owner's responsibility to prevent damage from foreign material or inadequate water treatment. See water treatment section in **section 1.6** of this manual for more information.
4. **FOR AUTOMATIC FILL:** Always install a manual shut off valve on the make-up water supply on the outside of the unit. When electrical power is applied to the unit and the display is in "Standby" or "Standby Ready" open the owner supplied shut off valve. The level switch will activate the make-up solenoid which will open and the water supply will fill the reservoir tank. **Do not use automatic fill when operating at a set point temperature below 48°F with glycol. Dilution may occur resulting with significant equipment damage.**
5. **MANUAL FILL:** Disconnect and lock out the electrical power supply and remove all necessary cover panels to access the reservoir. Add fluid directly to the reservoir. When the pump is first started, as process lines are filled and air is purged, additional fluid may be required to restore the reservoir to the correct level. Verify reservoir level via the coolant sight glass.
6. Do not use straight deionized or RO (reverse osmosis) water in this unit unless your unit was specifically designed for use with deionized water. Consult factory if not certain.



Typical coolant sight glass

B. PROPER ROTATION (PHASING) OF SCROLL COMPRESSORS & PUMPS & FANS

1. Correct compressor(s), propeller fan(s), centrifugal blower(s) (on air-cooled units) and pump(s) rotation is critical for unit performance and to avoid severe damage to the compressor.
2. All compressor(s), propeller fan(s), centrifugal blower(s) (on air-cooled units) and pump(s) will be set to rotate in the same direction during the testing process at the factory except for units with outdoor remote condensers. The rotation of compressors and pumps on units with remote condensers must be independently field checked for correct rotation by others.
3. After electrical installation the rotation must be checked by observing the pump motor shaft on the end of the pump and comparing its rotation to the directional arrow on the motor. If the rotation needs to be changed it should be done at the main power entry by switching any two power conductors at the terminal block or customer supplied main power disconnect. Recheck rotation before operating the units.



WARNING: The electrical power is engaged at this point. Caution must be observed while the electrical supply is engaged and cabinet panels are removed and opened.

4. Models with compressor module wire display Fault until the module has timed out.
5. Caution must be taken when checking rotation to avoid electrical shock.
5. A scroll compressor may make a loud rattling noise when rotating in the wrong direction.
6. Operating the scroll compressor in the wrong direction will cause the unit to trip on it's internal temperature limit and may cause unit damage. When the temperature limit trips, the compressor must be allowed to cool before it will restart. Thermal overload cooling and reset may take substantial time.
7. Procedure to set proper rotation:
 - a. Supply electrical power to the unit. Once the correct voltage is supplied to the unit, the control instrument will read "Standby" or "Status Ready". Adjust the setpoint to 70°F or higher to prevent the compressor from activating during this procedure. See Section 3.5 for additional details.



- b. Remove all necessary cover panels to access the pump motor.
- c. Locate the pump's electric motor. The operator must identify the motor shaft inside the electric motor housing. The motor shaft can be seen through the vent slots in the motor housing or by removing the shaft cover.

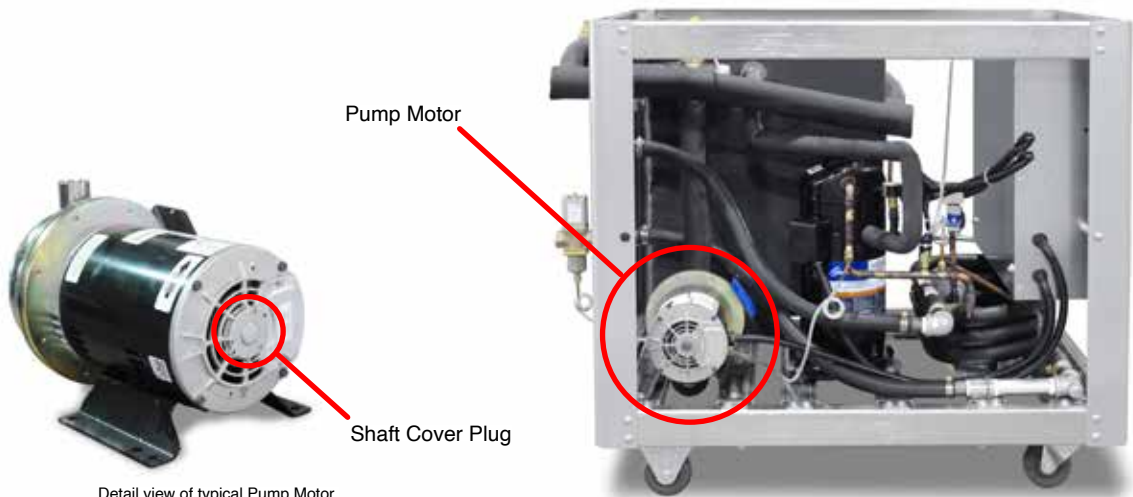

Detail view of typical Pump Motor.

Pump electric motor located on typical water-cooled unit.

- d. Depress the Green "I" start button then the Red "O" stop buttons. This will quickly cycle the pump motor.



- e. Remove the shaft cover plug to observe the motor shaft. When the unit is on, the motor shaft will rotate. When switched off, the shaft will slowly “coast” to a stop. As the shaft slows, the operator can identify the rotation of the motor shaft.

Correct rotation (correct phase) is “clockwise”, when viewed from the rear of the motor.



Correct shaft rotation is clockwise.

Incorrect rotation is “counter-clockwise” (incorrect phase) when viewed from the rear of the motor.

If the shaft does not rotate when the unit is switched on, the operator must identify the cause as outlined in the troubleshooting and repair section of this manual.

- f. If the motor shaft is phased correctly (shaft turns in a clockwise direction), continue with **step C**. If the motor shaft is **NOT** phased correctly (shaft turns in a counter-clockwise direction), correct as outlined in **step 2**.
2. If the unit is phased **incorrectly**, the operator must:
- a. Disengage the electrical power supply to the unit at the unit’s disconnect switch. Follow all facility proper lock-out tag-out procedures before proceeding.
 - b. Once the electrical power supply is disengaged the operator can change rotation by switching any two incoming power conductors at the terminal block or customer supplied main power disconnect.

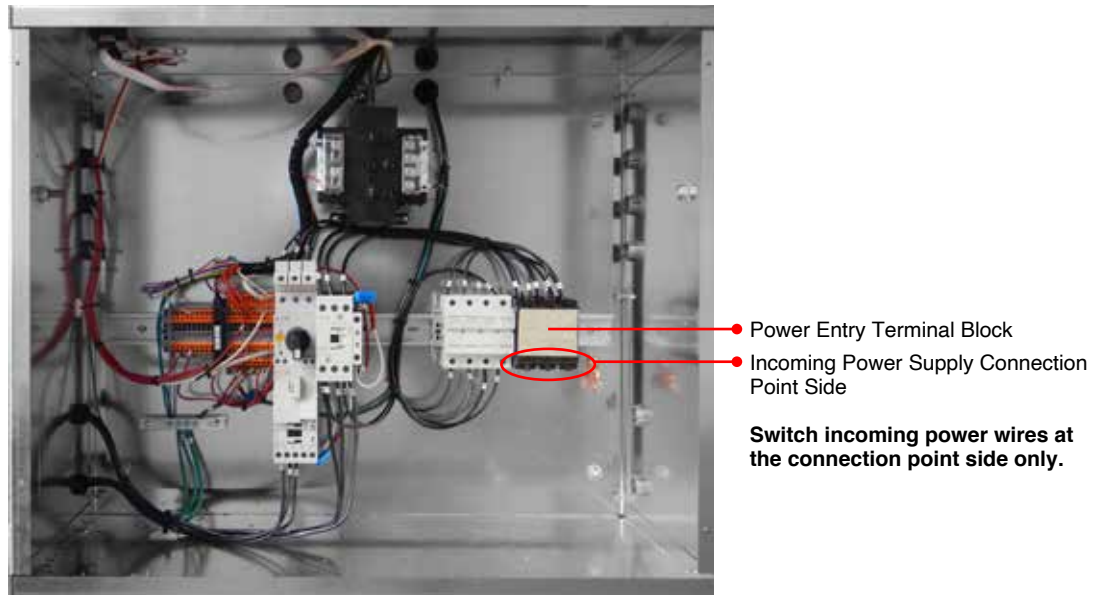

Typical electrical panel

C. PROCESS FLOW ADJUSTMENTS

1. The operator must determine and set proper water flow rate for the most efficient and trouble free operation.
 - a. Water flow rate through the process is determined by the pressure losses in the process loop. Generally, higher flow rates result in turbulent flow achieving maximum temperature control and lower maintenance. Since the evaporator in most liquid chillers is flow sensitive, the efficiency of operation is directly related to the flow of liquid.
 - b. Maximum chiller efficiency is obtained at approximately 2.4 gpm per ton of rated capacity. Low liquid flow can reduce efficiency and in some cases allow ice to develop in the evaporator which can damage the evaporator. Excessive liquid flow will trip the motor overload protection circuit.
2. Turn the unit on to activate the process pump. Wait a few moments to allow air to be purge from system. Observe the digital coolant pressure gauge for steady readout. Check unit for low and high flow.

3. **LOW FLOW**

If a low flow condition is present, be sure all process valves are open. If all process valves are open and a low flow conditions exists, consider the following:

- a. Low flow can cause the low refrigerant pressure limit switch to trip.
- b. To operate under a low flow condition it is necessary to install a flow bypass in the process circuitry. This will allow a portion of the flow to

bypass the process and return directly to the chiller. This keeps the total flow above the cutoff point. The illustration below show a typical bypass loop.

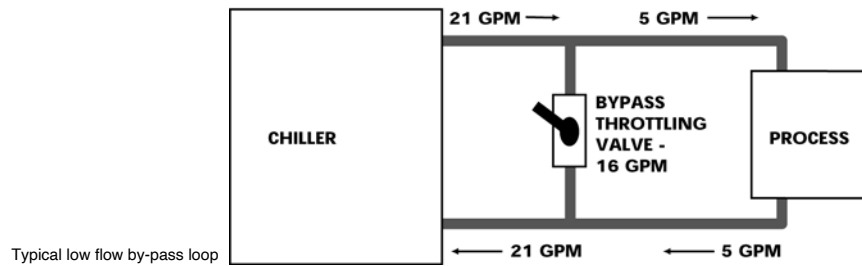

c. Some models may have a factory installed bypass. Follow the instruction in paragraph “d” below to adjust the low flow bypass.

d. Adjusting the Low Flow Bypass:

For Manual Low Flow Bypass Valves: Start with the bypass completely closed and gradually open the valve until the low refrigerant pressure digital display reading is in the normal operating range for the refrigerant type used in the chiller.

For Automatic Low Flow Bypass Valves: A “T” handle or adjusting stem is located on the top of the valve. Turning the “T” handle or adjusting stem in the clockwise direction puts more pressure on the valve’s spring reducing bypass flow. Turning the “T” handle or adjusting stem counter clockwise puts less pressure on the spring and increases bypass flow. Adjust the “T” handle or adjusting stem until the low pressure digital display reading is in the normal operating range for the refrigerant type used in the chiller. If the low pressure digital display reading is below normal, reduce the pressure on the spring to provide more bypass.

Automatic Low Flow Bypass Valve



4. **HIGH FLOW**

If a high flow condition is present:

- a. High flow can cause premature component wear and poor operating conditions.
- b. Adjust the flow so that an 8°F - 10°F rise in water temperature is indicated while the system is fully loaded.

5. If an excessive flow situation is encountered and the motor overload circuit has tripped, the operator must manually reset the overload relay before operations can continue. This is done by opening the electrical panel cover and identifying the motor overload relay.

Some overload relays have a red button that pops out if the overloads are tripper. Simply push the button in until the overloads are reset.

Other overload relays have a switch. This switch will be positioned with the indicator pointing up when in normal operation. The indicator will be pointing to the left when the overloads are tripped. To reset, simply turn the switch to where the indicator points up.

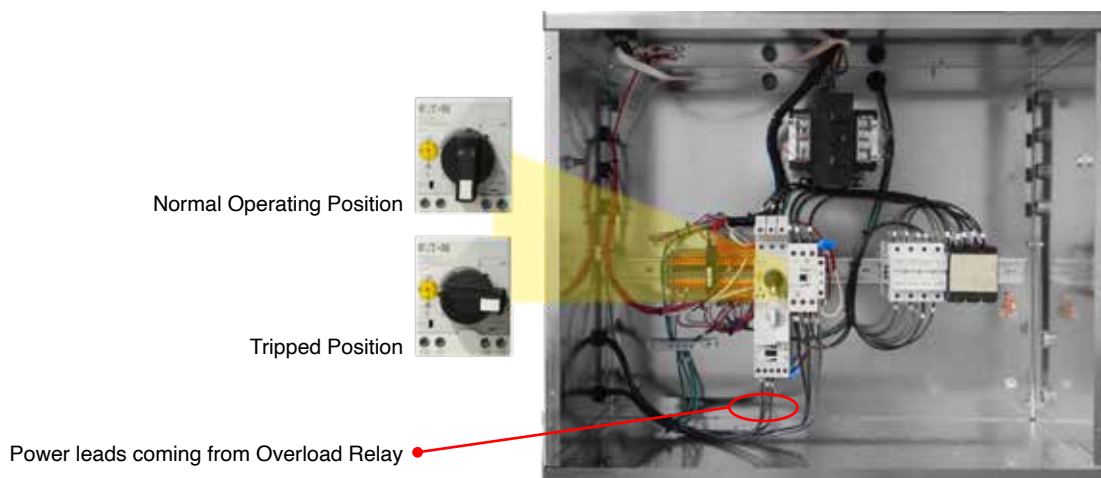

If a motor overload situation persists, the operator must adjust the flow rate to match the system pressure loss (reduce flow rate) to prevent continual tripping of the overload relay. This procedure is outlined here:

- a. Open electrical cabinet panel door. **Note that the electrical power is engaged at this point and caution must be observed while the cabinet panel is open.**



WARNING: The electrical power is engaged at this point. Caution must be observed while the electrical supply is engaged and cabinet panels are removed and opened.

- b. Identify the motor starter block. This block consists of the motor starter contactor and the overload relay.
- c. Place an amp meter on a single power lead coming from the overload relay.

Name plate on typical pump motor.



- d. Locate the motor name plate on the pump motor housing. The full load amp rating for the motor is listed on the name plate.
- e. Engage the electrical power supply and start the unit.
- f. The amp meter will display the motor amps. Compare the actual motor amps as displayed on the amp meter to the full load amp rating as listed on the motor name plate.
- g. If the amp draw is excessive (higher than the listed name plate amp rating), a throttling valve must be installed in the “from process” water line. The throttling valve can be a gate valve or a ball valve.
- h. With the throttling valve installed, fully close the valve and then engage the pump motor. Slowly open the throttling valve and monitor the motor amps as displayed on the amp meter until the actual motor amps equal the listed full load amp rating of the motor. The process flow is now correctly adjusted. The valve should remain in this position during operation.

C. SPECIAL CONSIDERATIONS FOR UNITS WITH REMOTE CONDENSER

- 1. Compressor and pump rotation must be check independently on units with remote condensers. Do not assume that the compressor is phased with the pump upon initial start-up.
- 2. If the pump is found to be rotating correct, the compressor must also be checked for proper rotation.

3.3 INSTRUMENT - CG Instrument



CG Series Control. This control instrument is used on units with fixed displacement compressors.

A. PRECAUTIONS

1. The chiller control is programmed from the factory with a setpoint range of 48° to 90°F. To operate below 48°F, the addition of inhibited propylene glycol and modification of the limit control settings are required. These adjustments are done from the chiller controller screen. Diligent monitoring of the water/glycol solution is mandatory to prevent freezing of the evaporator. Freezing may cause the evaporator to rupture allowing water and freon to mix which will cause major damage to the refrigeration system.
2. R134A and R407C models operating above 65°F and R404A models operating above 60°F require the addition of a refrigerant crankcase pressure regulating (CPR) valve. The CPR valve is necessary to lower the temperature of the gas returning to the compressor so that the compressor is cooled properly. R410A models may be operated up to 80°F without a CPR valve.
3. R410A models, please note then operating above 65°F, it is important to consider ambient temperature for condensing capability. High fluid temperatures with high ambient will impact condenser performance and may result in limit switch shut down. Consult Factory for selection assistance.
4. Contact your local refrigeration contractor or the factory for further information. The operating range of the chiller control may be changed to 0°F - 90°F by adjusting the Minimum Setpoint. Refer to Section 3.10D of this manual for more information.

B. STARTING THE UNIT

1. When the correct electrical power is supplied to the unit and the unit is filled with water or water/glycol, it is possible to start the unit.
2. Upon powered up, the instrument displays the Standby Screen.
 - a. **Status : Ready** indicates the unit is ready to start and there are no faults preventing operation.

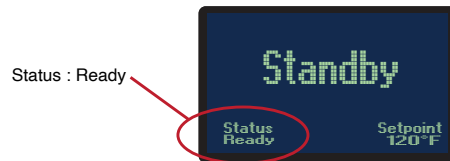

b. Status : Not Ready.

After applying power a screen that reads "Not Ready" typically indicates the presence of a sensor probe fault, pressure switch fault or motor overload fault. See the troubleshooting and maintenance portions of the manual for additional Information. **The fault must be corrected in order to continue operation of the unit.**

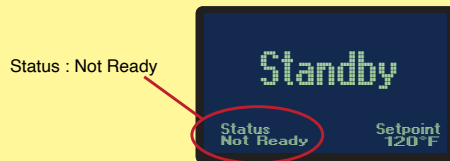

3. Press the Green "I" Button. "Circulating" will appear in the lower portion of the display window. The pump will circulate fluid without engaging the refrigeration system for about 45 seconds. Setpoint and the actual fluid temperature will be displayed as well.



4. To select setpoint temperature, press and hold the Up or Down Arrow keys until the desired setpoint temperature is displayed in the display window. The default range for the setpoint temperature is 48°F - 90°F or 9° - 32°C.



5. Press the Home button to view "Outputs", "Suction", "Discharge" and "To Process" values.



6. **Outputs:** Status indicators that show the state of the chiller's refrigeration system.

- a. When the four control status indicators are small, the refrigeration system is off and doing no cooling. The units pump will still be circulating fluid.

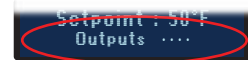

- b. When the first control status indicator is larger than the others, the compressor is operating at full capacity.

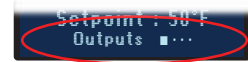

- c. For units with digital scroll compressors or fixed scroll compressors and hot gas bypass capacity control, when the first and fourth control status indicators are larger than the others the compressor is running and the capacity control feature is engaged indicating that the chiller capacity is greater than the cooling demand.

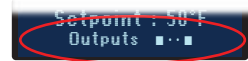

- d. The middle two status indicators are not used for chillers using single digital scroll compressors or fixed scroll compressors with hot gas bypass.

- e. Refer to Section 8.6 for other details concerning Status Indicators.

7. **Suction** indicates the refrigerant suction pressure, sometimes referred to as 'low' or 'evaporator' pressure.



8. **Discharge** indicates the refrigerant discharge pressure, sometimes referred to as 'high' or 'head' pressure.



9. **To Process** indicates the process cooling fluid (water or water/glycol) pressure.



10. When the compressor is turned off, the instrument will wait 3 minutes before turning it back on regardless of the To Process temperature or Setpoint.

If a low pressure or optional low flow fault has occurred, the control will attempt to turn the compressor back on after 3 minutes. If the fault condition remains, the compressor will not restart and the control will retry after 1 minute. The sequence will repeat 3 times then the system will lock-out and the unit must be powered off/on to restart the unit.

If a high pressure fault occurs the fault must be acknowledged by pressing the start button before the system will attempt to restart.

11. Under normal conditions (no fault conditions, compressor has been off for 3 minutes) the instrument will turn on the compressor when the To Process temperature is above the Setpoint. The instrument will engage the capacity control system (digital unloading or hot gas bypass) when the To Process temperature is below the Setpoint by no more than 3 degrees. Units equipped with a digital scroll compressor (includes a “D” in the model number such as CGD-10A) will operate in the unloaded state for a maximum of 50 seconds out of every 60 seconds.

The instrument will turn off the compressor and capacity control system when the To Process temperature is 4 degrees or more below the setpoint.

C. STOPPING THE UNIT



1. Press the red O button.
2. If the compressor is running when the off button is pressed the refrigeration system will stop but the pump will continue to circulate fluid for about 30 seconds to carry away residual cooling.
3. Pressing the stop button twice will immediately shut down the entire chiller including the process pump.
4. If the compressor is not running when the off button is pressed the chiller and pump will shut down.

3.4 Instrument : Main menu

- A. The Main Menu offers the ability to set and change values in the following areas:
Setpoints, Utilities, Network, Flow, Options, Machine



- B. The Main Menu is accessible from the Standby screen by pressing the Select button.



- C. The Main Menu is also accessible from any Operating screen by pressing the Select button. In the example below, while on the Cooling screen, pressing the Select button will advance to the Main Menu.

3.5 Instrument : Setpoints menu

- A. Under the Setpoints menu item, the values for the Process Setpoint, Hi Deviation, Low Deviation and Low Flow can be set or changed. Digital flow rate display is an option and may not be included on your machine.



- B. **Process Setpoint.** Use the Up or Down buttons to change the process setpoint.

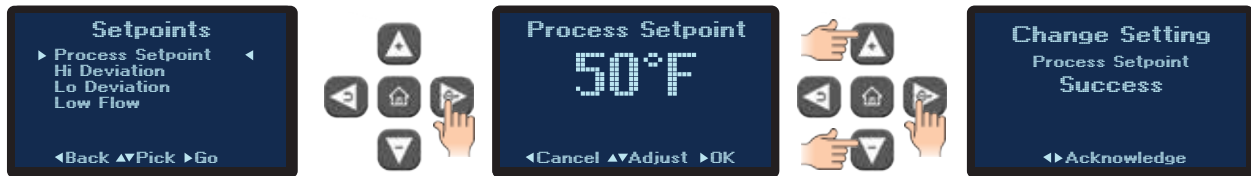

1. The Setpoint range is from 48°F to 90°F or 9° - 32°C.
2. Once acknowledged, the unit will control to the new setpoint temperature. Press the Back button repeatedly to return to the Setpoints screen or press the home button to return to the Home screen.

- C. Hi Deviation.** The High Deviation value programs the controller to sound the alarm if the process temperature exceeds the set difference from setpoint. For example, Hi Deviation = 10°F, Setpoint = 50°F. Hi deviation alarm will sound if the temperature reaches 60°F.



1. The factory default is 10°. The range for the Hi Deviation is from 0°F - 50°F.
2. With set points above 50°F, the maximum Hi Deviation setting should be no more than 100°F minus set point. For example, with a 70°F set point the High Deviation should not be set more than 30°F.
3. Once acknowledged, press the Back button repeatedly to return to the Setpoints screen or press the home button to return to the Home screen.

- D. Lo Deviation.** The Lo Deviation value programs the controller to sound the alarm if the process temperature exceeds the set difference from setpoint. For example, Lo Deviation = 10°F, Setpoint = 50°F. Lo deviation alarm will sound if the temperature cools to 40°F.



1. The factory default is 10°. The range for the Lo Deviation is from 0°F - 50°F.
2. With set points above 50°F, the maximum Lo Deviation setting should be no more than 100°F minus set point. For example, with a 70°F set point the Lo Deviation should not be set more than 30°F.
3. Once acknowledged, press the Back button repeatedly to return to the Setpoints screen or press the home button to return to the Home screen.

- D. Low Flow (optional feature not included on all units).** The Low Flow value programs the controller to sound an alarm if the process flow goes below the low flow set value. For example, if the flow set value is 3 GPM and if the flow goes below 3 GPM an alarm condition is indicated. Note: the low flow alarm feature is only available with the purchase of the optional flow meter.

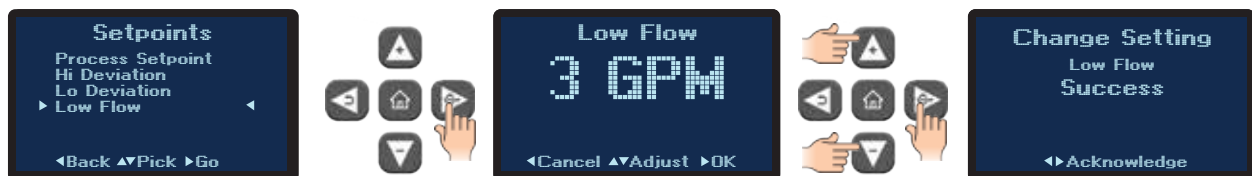

1. The factory default is 0 GPM. The range for the Low Flow is from 0 to 100 GPM.

2. Once acknowledged, press the Back button repeatedly to return to the Setpoints screen or press the home button to return to the Home screen.

3.6 Instrument : Utilities menu

- A. Items in the Utilities menu include the operations for the Software Version, Display Test and Sensor Display.



- B. **Software Version.** The software version number is the current version of the controller's software. This number can be useful when troubleshooting at times.



1. Select the Software Version item from the Utilities Menu to advance to the software version screen.
2. Press the Back button to return to the Utilities menu.

- C. **Display Test.** The Display Test will test the entire for bad pixels or sectors.



1. Select the Display Test item from the Utilities Menu to advance to the Display Test screen.
2. The test will show a blank screen. If any bad pixels or sectors are detected, those pixels or sectors will be dark. If dark pixels or sectors are indicated, contact the factory repair or replacement options.

- D. **Sensor Display.** There are up to 11 sensors the controller monitors.

1. Select the Sensor Display item from the Utilities Menu to advance to the first Sensor Display screen.
2. Scrolling through the Sensor Display reveals data for the sensor.

• To Process ... displayed in Fahrenheit and Celsius

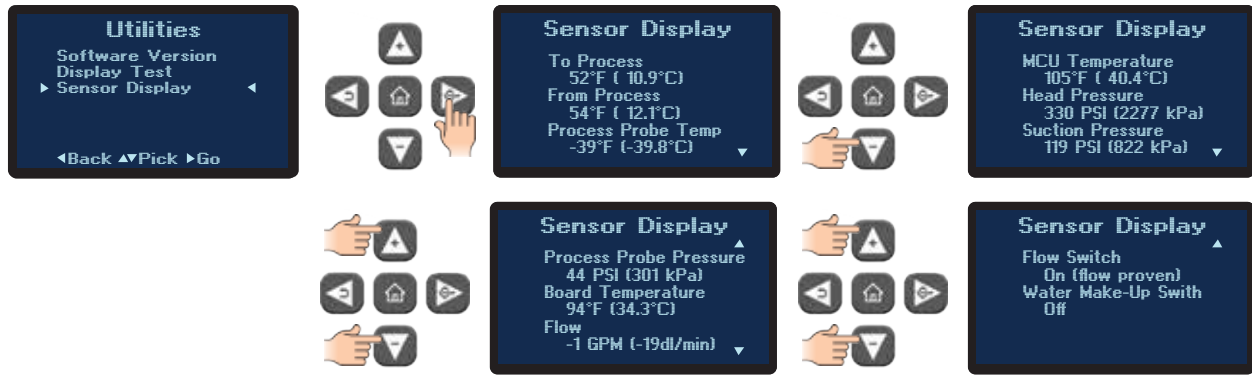

- From Process ... displayed in Fahrenheit and Celsius
- Process Probe Temperature ... displayed in Fahrenheit and Celsius (optional)
- MCU Temperature ... displayed in Fahrenheit and Celsius
- Head Pressure ... displayed in PSI and kPa
- Suction Pressure ... displayed in PSI and kPa
- Process Probe Pressure ... displayed in PSI and kPa
- Board Temperature ... displayed in Fahrenheit and Celsius
- Flow ... display in GPM and dl/min (optional)
- Flow Switch ... indicates on or off (optional)
- Water Make-Up Switch ... indicates on or off (optional)

3.7 INSTRUMENT : NETWORK MENU

A. Items in the Network menu include Protocol, Address and Baud Rate

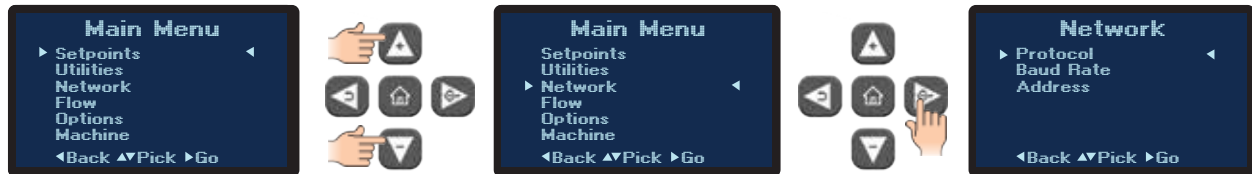

B. **Protocol:** This is the data format for communication between the unit and the host computer. Available values are SPI CCP, Modbus RTU and CAMAC. SPI is the standard Society of Plastics Industry, Inc. protocol. CAC is the CAMAC protocol used on older Milacron machines. Modbus RTU is used in serial communication and is a common serial communications protocol for industrial equipment.

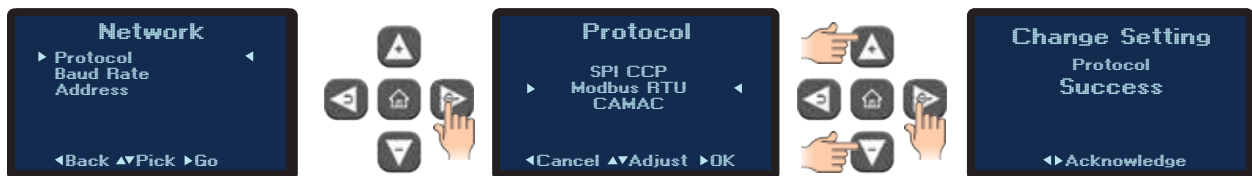

1. Press the Select button to select Protocol.
2. Use the Up or Down arrow buttons to select the preferred protocol.
3. Use the Select button to save the selection and confirm success.

C. Baud Rate: This is the data transfer rate between the unit and the host computer.

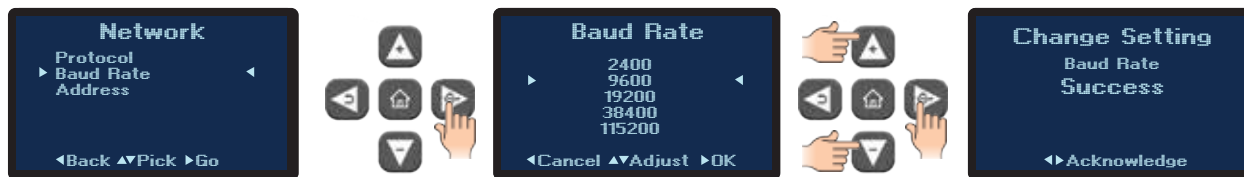

1. Press the Select button to select Baud Rate.
2. Use the Up or Down arrow buttons to select the baud rate. The available rate units are 1200, 2400, 9600, 19200 and 38400.
3. Press the Select button to save the selection and confirm success.

D. Address: This is the number assigned to the unit in a network.



1. Press the Select button to select Address.
2. Use the Up and Down arrow keys to select the address for this unit. The factory default is 1. The selection range is from 1 - 10.
3. Press the Select button to save the address and confirm success.

3.8 INSTRUMENT : FLOW MENU (Option)

A. The Flow Menu is only functional when the optional flow meter is installed. Items in the Flow Menu are Enable, Offset and Calibration.

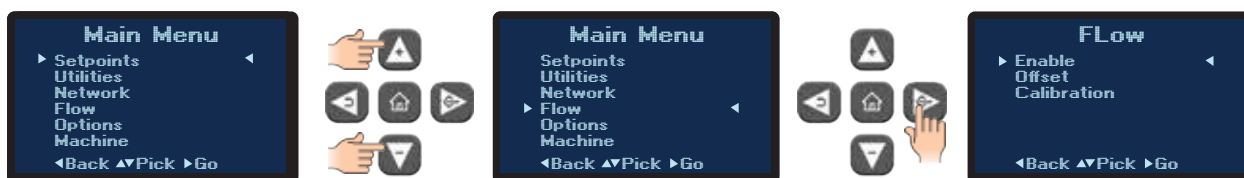

B. Advance to the Flow Enable / Disable screen. Select Enabled to enable the flow option.

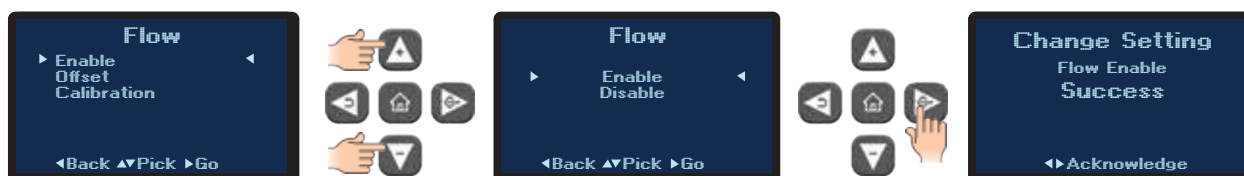

C. Offset. This allows the user to select the flow offset according to the pump horsepower.



1. These values should be factory set and should not be changed. Adjust only if they are set to values other than the factory default.

D. Calibration. This allows the user to calibrate the unit's flow meter.



1. Using a reliable and accurate external flow meter the user can input a calibration constant value in the screen so that the unit flow display matches the external flow meter.
2. Use the Up or Down arrow keys to input the value and then press the Select button to save and confirm success.

3.9 INSTRUMENT : OPTIONS MENU

A. The single selection under the Options menu is the Remote Start.

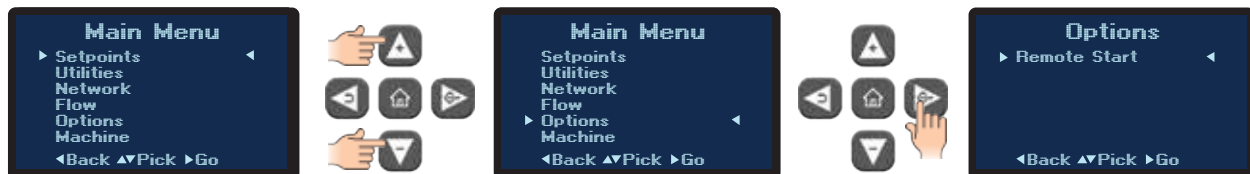

B. Please note: this option requires factory or field installation of optional equipment.

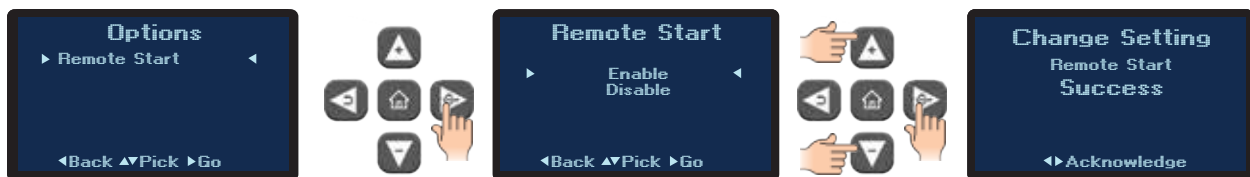

1. Select Remote Start from the Options menu.
2. Advance to the Remote Start Enable / Disable screen. Select Enabled to enable the remote start feature. Select Disabled to disable the feature.
3. Once acknowledged, press the Back button repeatedly to return to the Options screen or press the home button to return to the Home screen.

3.10 INSTRUMENT : MACHINE MENU

- A. The Machine Menu allows the units to set values for these items :
- User Parameters Normally Adjusted in Field** : Set Date, Set Time, Min Setpoint, Hi Temp Shutdown, Units, From Process.
 - These Parameters are Factory set and should not be adjusted without consulting the Factory** : LP Cut Out, LP Cut In, LP Start Up Delay, LP Run Delay, HP Cut Out, Secondary Pump, Chiller Type, Cooling Source.

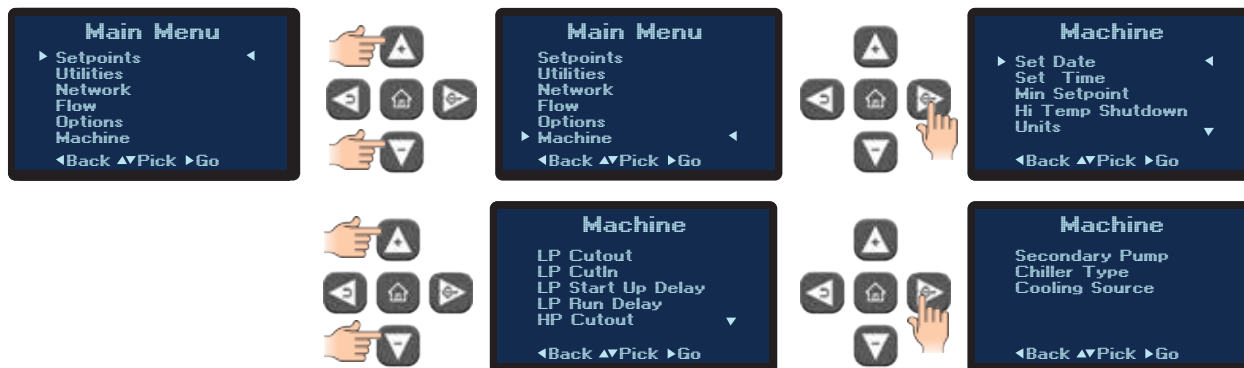

B. Set Date

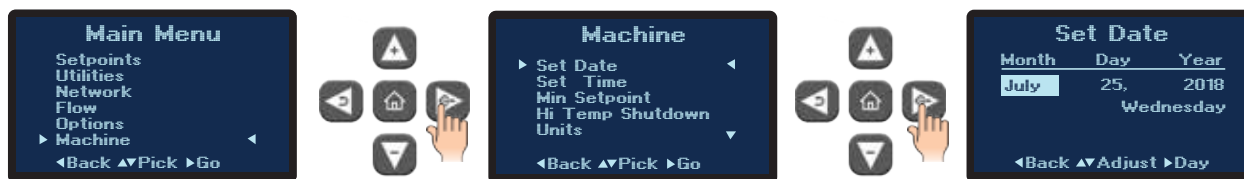

- Set the date by selecting the Set Date option from the Machine Menu. Using the Up and Down Arrow keys to select the month, day and year. Use the Select and Back Buttons to advance between Month, Day and Year.

C. Set Time.

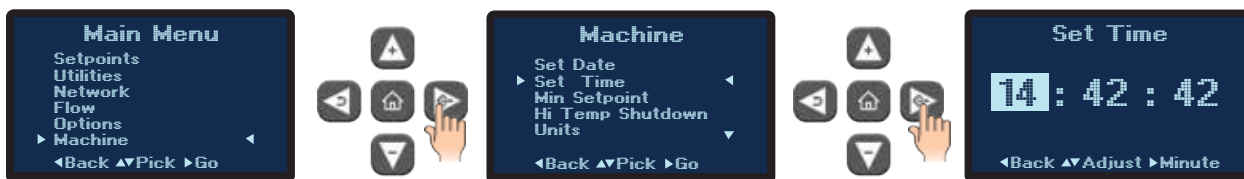

- Set the time by selecting the Set Time option from the Machine Menu. Using the Up and Down Arrow keys to select the hour, minute and seconds. Use the Select and Back Buttons to advance between Hour, Minute and Seconds.

D. Minimum Setpoint. This parameter sets the lowest permissible setpoint temperature. The factory default is 48°F. The range is from 0°F - 90°F.

- For Minimum Setpoints below 48°F.** A warning is displayed when a minimum

setpoint below 48°F is entered. The warning ensures the operator is aware the an appropriate mixture of water/glycol is circulating to prevent freezing.



2. After a minimum setpoint below 48°F is selected, a caution display will appear when reducing the operating setpoint below 48°F. The warning must be acknowledged before the change is made by pressing the Select button.

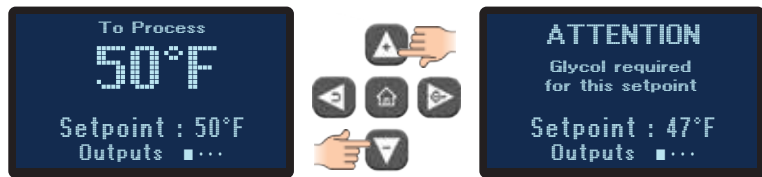

3. **For Minimum Setpoints 48°F and above.** From the Machine Menu, advance to the Minimum Setpoint screen to enter the minimum setpoint. Confirm the selection with the Select Button.

E. Hi Temp Shutdown. This shuts down the unit if process temperature exceeds the selected value to prevent excessively warm fluid temperature.



1. From the Machine Menu, select Hi Temp Shutdown via the Up or Down Arrow keys. Adjust the temperature as desired. Select button to save and confirm success.
2. The factory default value is 100°F. The range is from 65°F - 110°F.

F. Units. This screen controls how the temperature is displayed. The options are English (°F) or Metric(°C). Also, when the optional flow meter is installed, the flow will display in GPM if English is selected or LPM if Metric is selected.

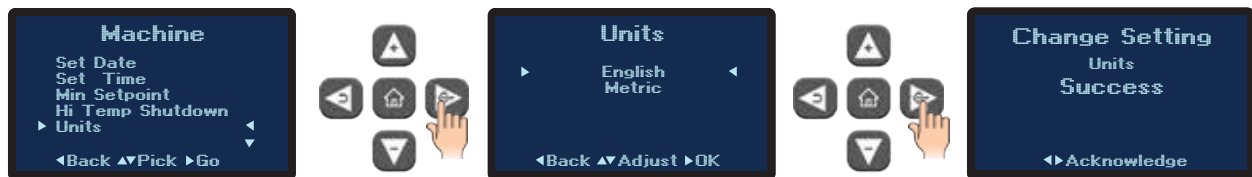

1. Use the Up or Down arrow keys to select the Unit display and then press the Select button to save and confirm success.
2. The factory default value is English.

- G. Pressure and Timer Screens.** These parameters are factory set and should not be adjusted without consulting the factory. Changes are recorded in the instrument memory and adjusting these parameters could void the Factory warranty.

Pressure Related :

- LP Cut Out
- LP Cut In
- HP Cut Out

Timer Related :

- LP Start Up Delay
- LP Run Delay

- H. Unit Screens.** These parameters are factory set and should not be adjusted without consulting the factory. Changes are recorded in the instrument memory and adjusting these parameters could void the Factory warranty.

- Secondary Pump
- Chiller Type
- Cooling Source



3.11 LOW TANK LEVEL

- A. Most models include a level switch that monitors the tank fluid level and provides a warning when the tank level is low and needs to be refilled.
- B. The chiller will start up the pump when a low level condition exists. If the low level condition continues after about one minute a low level fault is displayed the instrument.
- C. The alarm may be silenced by pressing the green button.
- D. The fault will continue to be shown on the instrument display. The usual home screen will not be visible. The setpoint can be checked and changed through the menu system and the “To Process Temp” is available in the sensor section. The compressor will activate and provide cooling if needed after its 3 minute delay, but the fault screen will still be on the home screen until the water level satisfies the level switch.

Typical Level Switch shown.

In some models, the level switch is placed behind a stainless steel barrier to isolate the level switch from water turbulence in the reservoir tank.

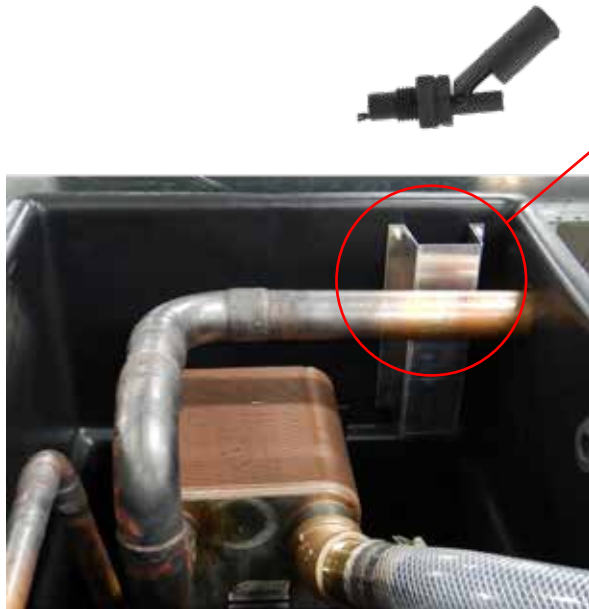



WARNING: *Relieve static pressure before disconnecting process lines.*



WARNING: *Follow all shut down procedures outlined in this manual.*

3.12 SHUT DOWN/DISCONNECT SEQUENCE

A. PRECAUTIONS/WARNINGS

1. The operator must follow all shut down procedures outlined in this manual. If the operator fails to follow all procedures outlined in this manual, an unsafe condition can develop resulting in damage to the unit or personal injury.

B. UNIT SHUT DOWN

1. To shut down the unit without disconnecting from the process:
 - a. Press the red O button.
 - b. If the compressor is running when the off button is pressed the refrigeration system will turn off but the pump will continue to run for about 30 seconds to carry away residual cooling that could damage the unit.
 - c. Pressing the stop button twice shut down the entire chiller including the process pump at once.
 - d. If the compressor is not running when the off button is pressed the chiller and pump will shut down.
2. To shut down the unit and disconnect from the process:
 - a. Press the red O button.
 - b. Discharge any static pressure in the process fluid lines and condenser water supply lines (water-cooled units).
 - c. Disconnect all process lines.

4.0 TROUBLESHOOTING

- 4.1** Unit Will Not Start
- 4.2** Compressor Hums But Will Not Start
- 4.3** Shuts Off On High Pressure
- 4.4** Shuts Off On Low Pressure
- 4.5** Compressor Shuts Off On Internal Overload
- 4.6** Low or No Process Pressure or Water Flow
- 4.7** Cooling Capacity Inadequate
- 4.8** Sensor
- 4.9** Pumps
- 4.10** Chiller Controller
- 4.11** Replacement Controller Configurations





WARNING: Before troubleshooting or servicing this unit, follow all company lock-out tag-out procedures.

4.1 UNIT WILL NOT START

- A. **Power off.** Check main disconnect.
- B. **Main line open.** Check fuses.
- C. **Loose terminals.** Tighten terminals with POWER OFF.
- D. **Control circuit open.** Check control voltage fuses and transformer.

4.2 COMPRESSOR HUMS BUT WILL NOT START

- A. **Contactor problem.** Check contacts and contactor operation.
- B. **Low voltage.** Check voltage at main and at the unit. If voltage is OK at the main but low at the unit, increase wire size. If low at main, consult your local power company. Voltage must be +/- 10% nameplate rating.
- C. **No power on one phase of a three phase unit.** Check fuses in control panel and main disconnect. Also check unit wiring, main plant fuse and wiring. If the problem is with the main power supply coming into the plant, call the local power company.
- D. **Loose terminals.** Power off and follow all company lock-out tag-out procedure before tightening terminals.

4.3 SHUTS OFF ON HIGH PRESSURE LIMIT

A. Air-cooled units:

- 1. **Insufficient condenser air flow.** Check condenser filter for dirt, fins may be plugged with dirt or foreign material. Also, check for proper fan rotation.

Note: All enclosure panels must be attached.

- 2. **Fan motor not operating.** Have electrician check fuses and wiring, motor starter and overloads, and motor. Repair or replace motor if defective.

B. Water-cooled units:

- 1. **Water regulator valve.** Adjust condenser water regulator valve to maintain 100°F to 105°F refrigerant condensing temperature*. If valve is defective, have valve repaired or replaced by a refrigeration serviceman.
- 2. The water regulator valve is normally factory set for proper operation. When field adjustments are required, turn the adjusting nut on the top of the valve counter

* See Temperature-Pressure chart in Section 8.2 for refrigerant pressure.

clockwise to raise the refrigerant pressure and clockwise to lower the pressure. Adjustments should be made only when the chiller is running at full load.

3. **Insufficient condenser water flow.** Check condenser water pumping system.
 4. **Condenser water temperature too high.** Check cooling tower for proper operation if used and the city water temperature if city water is used.
 5. **Condenser water tubes scaled.** Clean with brushes and chemicals approved by the Manufacturer's Service Department.
- C. **Improperly set high pressure control.** Have refrigeration serviceman reset or replace the control if defective. Contact the Manufacturer's service department for the proper settings. Adjust on chiller control instrument.

4.4 SHUTS OFF ON LOW PRESSURE CONTROL

Note: Refrigerant low pressure limits are set on and monitored by the CG control instrument. If the set low pressure limit is reached the refrigeration system is turned off by the control. The low pressure limit automatically resets when the pressure rises above the cut-in pressure value after a pre-set time delay to avoid short cycling. If the low pressure does not reset contact the manufacturer's service department for instructions.

If the unit low pressure limit is activated three (3) consecutive times during start-up the unit will lock out and will not be allowed to start. When the chiller control locks out due to low pressure after three (3) attempts, there is a problem that must be resolved before the unit should be restarted. To re-start, the unit must be powered down and back on. This should only be attempted after the cause of the low pressure condition has been found and the issue has been resolved. Repeatedly re-starting the unit will cause damage to the unit often including freezing and rupture of the chiller evaporator.

The low pressure switch is set to cut-out at 32°F and cut-in at 36°F - 39°F*. If a low pressure condition exists for more than five seconds the compressor will stop and a fault occurs.

* See Temperature-Pressure chart in Section 8.2 for refrigerant pressure.

After the refrigerant pressure rises above the cut-in pressure, a three minute time delay will occur before the compressor restarts. This will protect the evaporator and compressor from damage should a problem occur in the refrigeration system or if the chiller is operated under circumstances which could cause damage to the refrigeration system.

A. **Low or no water flow through the evaporator.** Adjust the flow per section 3.2.C.

B. **Air-cooled units:**

Head pressure too low. Check that the entering air temperature is above 60°F. If below 60°F, find out reason why.

C. **Water-cooled units:**

Head pressure too low. Adjust condenser water regulating valve to maintain 100°F - 105°F refrigerant condensing temperature*. Have a refrigeration serviceman repair the valve or replace if defective.

* See Temperature-Pressure chart in Section 8.2 for refrigerant pressure.



The water regulator valve is normally factory set for proper operation. When field adjustments are required, turn the adjusting nut on the top of the valve counter clockwise to raise the refrigerant pressure and clockwise to lower the pressure. Adjustments should be made only when the chiller is running at full load.

- D. **Low refrigerant charge.** Check for adequate refrigerant charge (bubbles or misty sight glass indicates low charge). If charge is low, have system checked for leaks and recharged by a refrigeration serviceman.
- E. **Improperly set low pressure limit setting.** Reset control to proper value. Have a refrigeration serviceman reset control or replace if defective.
- F. **Restriction in the liquid line.**
 - 1. **Clogged filter drier.** Check for pressure or temperature drop and have drier core replaced by a refrigeration serviceman.
 - 2. **Liquid line valve or suction valve on compressor is partially closed.** Open fully.
 - 3. **Liquid line solenoid not opening fully or leaking during off cycle.** Have the solenoid repaired or replaced if defective by a refrigeration serviceman.
 - 4. **Expansion valve plugged or inoperative.** Check thermal bulb and capillary tube for damage. Have bulb and/or tube repaired or replaced if defective by a refrigeration service man.

4.5 COMPRESSOR SHUTS OFF ON INTERNAL OVERLOAD

- A. **Control does not reset.** Have compressor windings and internal solid state safety control checked by a refrigeration serviceman. Have it repaired or replace if defective.

4.6 LOW OR NO PROCESS PRESSURE OR WATER FLOW

- A. **Valves.** Check if water valves are open.
- B. **Pump.** Check pump for correct rotation. Check pump suction for restriction. Replace motor if defective.
- C. **Filters.** Check filter in the chilled water circuit and clean if necessary.
- D. **Pressure switch (or flow switch).** Readjust or replace if defective.
- E. **Fuses and wiring.** Have electrician check the fuses and wiring.

4.7 COOLING CAPACITY INADEQUATE

- A. **Low refrigerant charge.** Check for adequate refrigerant charge (bubbles or misty sight glass indicates low charge). If charge is low, have system checked for leaks and recharged by a refrigeration serviceman.



- B. **Hot Gas Bypass open or digital unloading valve inoperative.** Have repaired or replace if defective by a refrigeration serviceman.
- C. **Expansion valve plugged or inoperative.** Check thermal bulb and capillary tube for damage. Have bulb or tube repaired or replaced if defective by a refrigeration serviceman.
- D. **Plugged filter.** Check filter in chilled water circuit and clean.
- E. **Air in system.** Purge air.

4.8 SENSOR

- A. The sensor is a solid state temperature transducer which converts temperature input to a proportional current output.
- B. To quickly test for a defective probe, switch connections between the defective probe and a probe known to be working properly. A defective sensor will display a "---" in the display window on the instrument control.



Typical chilled water sensor probe with 2 pole connector.

4.9 COOLANT PUMP

- A. The centrifugal pump is designed to operate at a specific flow and pressure at the maximum run load amp draw of the motor. Too much flow can overload the motor and cause the overload circuit to open and stop the pump.
- B. If the overload trips, check for electrical shorts, loose wires, or blown fuses. If these check OK, reset the overload circuit and restart the chiller.

4.10 CHILLER CONTROLLER

- A. The control instrument is used for all normal set ups, diagnostics, temperature readout and operational information. It contains the software and electronic components which operate the control instrument.
- B. The control instrument is not field repairable. It can be easily removed and replaced or repaired if a problem occurs.
- C. All control instruments used in these water chillers are covered by the machine's warranty. Proprietary "tailor made" instrument are manufactured specifically for the Manufacturer.

If you experience problems with your control instrument, it's as easy as 1-2-3 to execute our repair or replacement system in order to get your equipment running.

D. IN WARRANTY SERVICE INCIDENT

1. Call Manufacturer Service Department for diagnostic assistance.
2. If a control instrument is determined to be at fault, a new or reconditioned instrument will be sent as a replacement.

3. Return the defective instrument freight pre-paid for a full credit. If the faulty instrument is not returned you will need to pay for it.

E. OUT-OF-WARRANTY SERVICE INCIDENT

1. Call Manufacturer Service Department for diagnostic assistance.
2. If a control instrument is determined to be at fault, you will be referred to the instrument manufacturer, you have 3 options:
 - a. Purchase a new instrument as a replacement.
 - b. Send your instrument back for repair, freight prepaid. For a nominal fee (contact factory for current fees) your instrument will be repaired and returned.
 - c. Purchase a new instrument and repair the old one as a back up.

F. OTHER INFORMATION

1. Repair Warranty: 1 year.
2. **Ship to Manufacturer.**
3. Include in box: part, purchase order, contact name, phone number, symptom (if available).



4.11 REPLACEMENT INSTRUMENT CONFIGURATION

- A. A replacement instrument must be configured properly to operate as intended. Failure to configure the instrument can result in poor unit performance and may damage the chiller.
- B. The list below provides the current available configuration settings for the MG instrument. Prior to operating the chiller after an instrument replacement, the instrument must be configured to the proper setting per the attached list. Contact the Advantage service department for assistance in determining the proper configuration for your chiller. 317-887-0729
- C. To check the configuration, follow these steps.
 1. Prepare unit with power applied to unit but not operating.

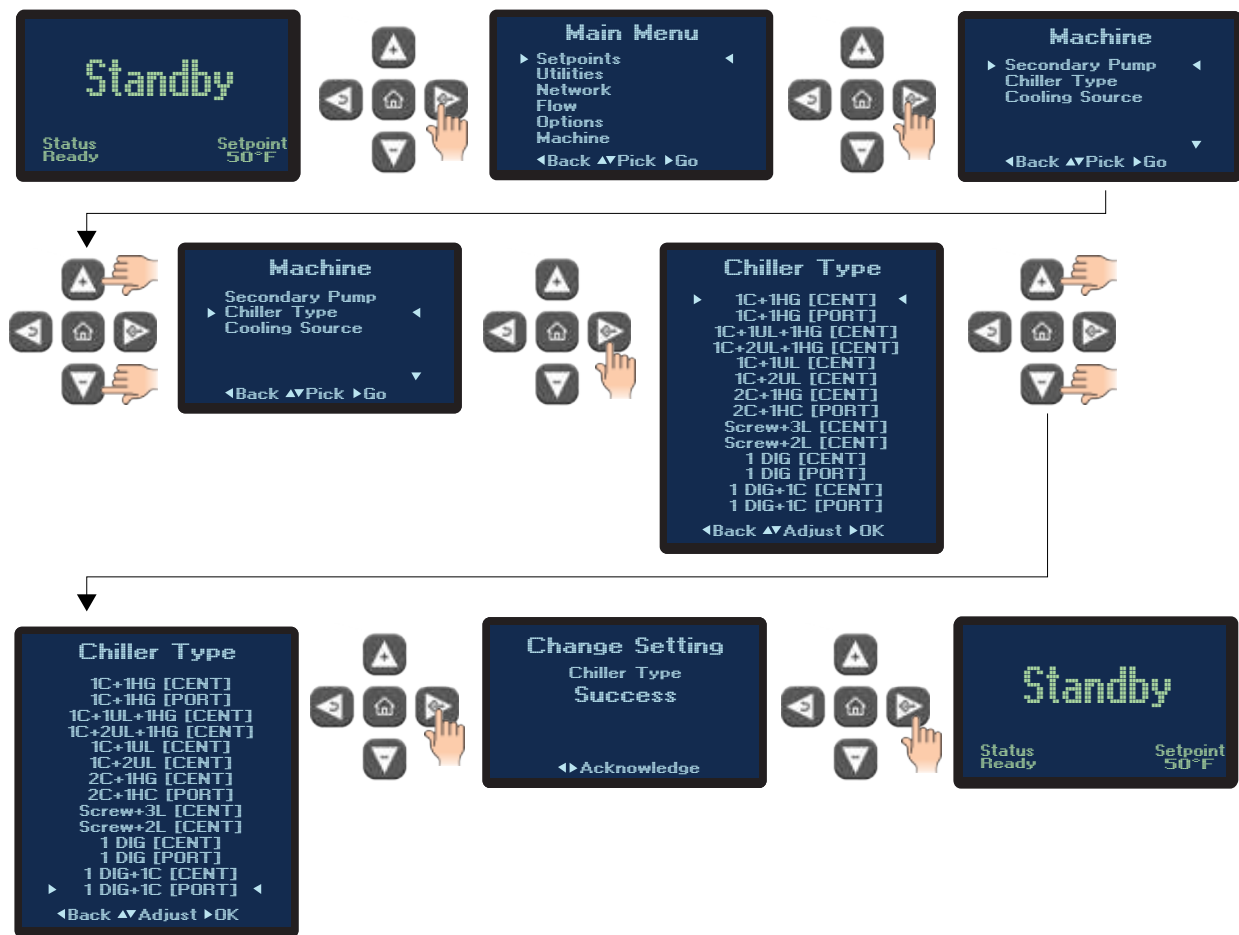

2. On the MG control instrument, press 'Machine'.
3. Press 'Chiller Type'. The current configuration is highlighted by arrows.
4. If the configuration is correct, no further action is required.

5. If the configuration is not correct:
 - a. Use the Up and Down Arrow buttons to select the correct Chiller Type. See the chart below for available chiller configurations.

MG Chiller - Chiller Type Configuration

Number	MG Display	Chiller Type OUtput Summary	Chiller Type	Output 1	Output 2	Output 3	Output 4
1	1C + 1HG [CENT]	1 Compressor, 1 Hot Gas Bypass	Central	Compressor	XXX	XXX	Hot Gas Bypass
2	1C + 1HG [PORT]	1 Compressor, 1 Hot Gas Bypass	Portable	Compressor	XXX	XXX	Hot Gas Bypass
3	1C + 1UL + 1HG [CENT]	1 Compressor, 1 Unloader, 1 Hot Gas Bypass	Central	Compressor	Unloader	XXX	Hot Gas Bypass
4	1C + 2UL + 1HG [CENT]	1 Compressor, 2 Unloaders, 1 Hot Gas Bypass	Central	Compressor	Unloader	Unloader	Hot Gas Bypass
5	1C + 1UL [CENT]	1 Compressor, 1 Unloader	Central	Compressor	Unloader	XXX	XXX
6	1C + 2UL [CENT]	1 Compressor, 2 Unloaders	Central	Compressor	Unloader	Unloader	XXX
7	2C + 1HG [CENT]	2 Compressors, 1 Hot Gas Bypass	Central	Compressor	Compressor	XXX	Hot Gas Bypass
8	2C + 1HG [PORT]	2 Compressors, 1 Hot Gas Bypass	Portable	Compressor	Compressor	XXX	Hot Gas Bypass
9	Screw + 3L [CENT]	1 Screw Compressor w/ Pulse	Central	Compressor	50% Capacity	75% Capacity	Pulse
10	Screw + 2L [CENT]	1 Screw Compressor w/o Pulse	Central	Screw Compressor	50% Capacity	75% Capacity	XXX
11	1DIG [CENT]	1 Digital Scroll	Central	Digital Scroll Compressor	XXX	XXX	XXX
12	1DIG [PORT]	1 Digital Scroll	Portable	Digital Scroll Compressor	XXX	XXX	XXX
13	1DIG + 1C [CENT]	1 Digital Scroll Compressor, 1 Compressor	Central	Digital Scroll Compressor	Compressor	XXX	XXX
14	1DIG + 1C [PORT]	1 Digital Scroll Compressor, 1 Compressor	Portable	Digital Scroll Compressor	Compressor	XXX	XXX

- b. Use the Right Arrow button to make the selection. A Change Setting Chiller Type screen will appear.
 - c. Use the Left or Right Arrow buttons to acknowledge the selection and return to the Home Screen.
7. Once configured correctly the unit is ready to operate.



5.0 MAINTENANCE

- 5.1** Warranty Service Procedure
- 5.2** Periodic Preventative Maintenance
- 5.3** Special Maintenance
- 5.4** Solenoid Valve Service
- 5.5** Pump Seal Service
- 5.6** Checking the Refrigerant Charge
- 5.7** Proper Cleaning Procedure for Brazed Plate Evaporator



5.1 WARRANTY SERVICE PROCEDURE

- A. In the event of a problem with a chiller that can not be resolved by normal troubleshooting procedures, the customer is invited to consult the Service Department for assistance. The correct model number and serial number of the chiller must be available. The service department will attempt to isolate the problem and advise repair procedures. Often times, with the customer's input and with the machine diagnostics, problems can be determined with "over-the-phone" consultation.
- B. If the problem is beyond the scope of "over-the-phone" consultation, and if the warranty status of the machine is valid, the Manufacturer will contact the nearest authorized service contractor and provide authorization to conduct an "on-site" inspection of the unit in order to determine the course of repair. If the chiller is not covered by the warranty, the Manufacturer will advise on the repair and recommend available service contractors.
- C. It is of the utmost importance that you provide the correct model number and serial number of the machine in question. This will allow the Service Department to obtain the correct manufacturing records which will help to properly troubleshoot the problem and obtain the proper replacement parts when they are required. This information is stamped on the data tag that is attached to the electrical enclosure of each machine.
- D. The Service Department must be notified prior to any repair or service of a warranty nature. Warranty claims will not be honored without prior authorization.

5.2 PERIODIC PREVENTATIVE MAINTENANCE

- A. Lubricate all motors. Note that some motors are supplied with sealed bearings.
- B. Tighten all wire terminals.
- C. Check and tighten all water connections & hose clamps.
- D. Clean and check motor starter and contactor contacts.
- E. Check safety switch settings.
- F. Clean condenser fins of dust and dirt (air cooled models only).
- G. Back flush evaporator.
- H. Check glycol/water solution ratio for operating temperature.
- I. Check system for leaks. Tighten all water fittings and hose clamps. Replace defective hose clamps as required.
- J. Refrigerant sight glass: Check for bubbles when compressor is operating at 100%. Check the moisture indicator for a color other than green.
- K. Clean unit.



5.3 SPECIAL MAINTENANCE

- A.** Any service of the refrigeration system must be accomplished by a certified refrigeration technician.
1. Addition of compressor oil.
 2. Addition of refrigerant.
 3. Repair of a refrigerant leak.
 4. Adjustment of super heat.
 5. Changing of filter-drier or drier core.
 6. Repair of a refrigeration solenoid.



5.4 AUTOMATIC WATER MAKE-UP SYSTEM SERVICE

A. The automatic water make-up system consists of a level switch (figure 5.4A) and a solenoid valve (figure 5.4B). When the tank level is low the level switch signals the solenoid valve to open allowing make-up water to re-fill the tank.

B. Level switch maintenance and service.

1. The level switch contacts engage and disengage the water make-up solenoid valve.
2. Poor water quality can allow debris or a film build-up on the level switch contacts which can impair operation. Clean the contacts on a regular basis. If cleaning the contacts does not remedy the problem the level switch must be replaced.

C. Make-up solenoid valve service.

1. The make-up solenoid valve may require service for a failed coil or more often it will not fully close because debris from poor make-up water quality is in the valve mechanism.
2. To replace the coil, disengage power from the unit following all lock-out/tag-out procedures. Remove the wires from the failed coil and remove the coil from the valve stem. Install the new coil on the stem and reconnect the wires.
3. To service the solenoid valve follow the procedure below.
 - a. Disengage process operations. Be certain process fluid pressure is relieved (coolant pressure is "0") and water system flow is shut off.
 - b. Disengage main power supply. The operator must follow all lockout/tagout procedures.
 - c. Remove or open any access cover panel and set aside to gain access to the make-up solenoid valve.
 - d. The solenoid valve can be disassemble by removing the 4 retaining screws.
 - e. Keeping all electrical connections intact, lift the coil and top solenoid base assembly and set aside.
 - f. **Note the arrangement of the core spring and core assembly, diaphragm spring and diaphragm assembly. (See diagram.)**
 - g. Clean all components as required.



Typical water make-up level switch Figure 5.4A



Typical water make-up solenoid valve Figure 5.4B

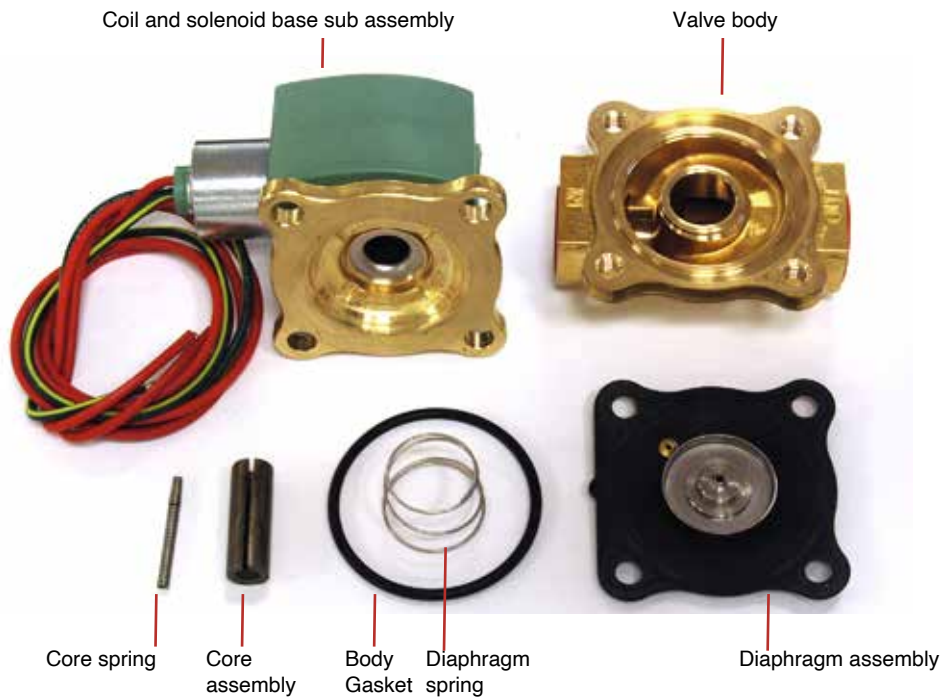
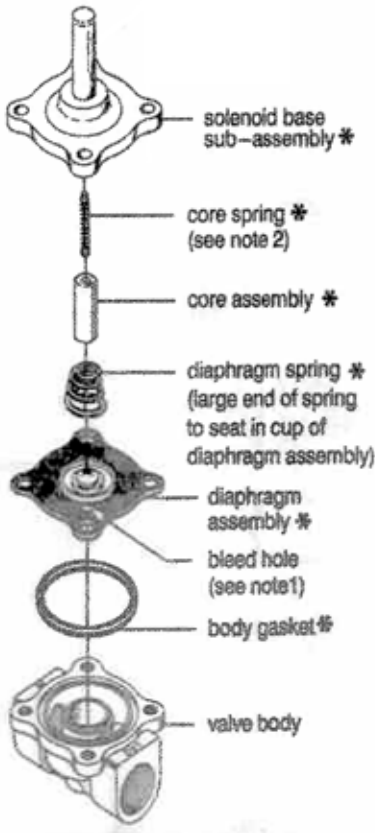

5.5 PUMP SEAL SERVICE

A. The coolant pump seal is a carbon/niresist shaft seal assembly including a stationary member, rotating member and tension spring (figure 5.5A).

B. The operator can determine the pump seal is leaking when fluid is identified leaking from the pump case adapter. Generally, a pump seal will leak due to inadequate unit pressure, excessive flow and/or poor fluid quality.

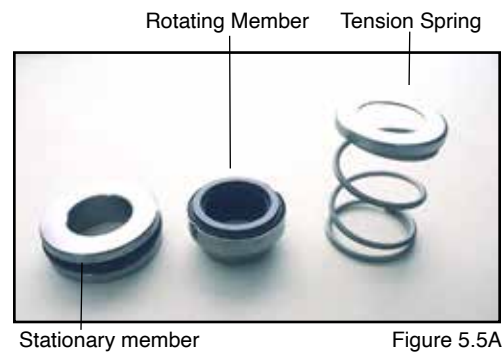

C. The operator should follow this procedure to replace the pump seal:

1. Disengage process operations. The operator must be certain process fluid temperature is under 100°F and pressure is relieved (coolant digital pressure gauge reads “0”) and water make-up flow is shut off and all pressure relieved.
2. Disengage main power supply. The operator must verify the proper lockout procedures are followed.
3. Access the pump motor by opening or removing any cover panels as necessary (figure 5.5B).
4. Drain machine. The machine can be drained by using the drain valve located on the pump case. Drain fluid into a suitable container for reuse or disposal according to manufacturer’s instructions (if a glycol solution is used).
5. Locate and remove the three motor wire leads from the motor wiring terminals. The operator should “map” the wire terminal locations to ensure correct rewiring. The power cord should be removed from the motor housing (figure 5.5C).
6. Locate and remove the pump casing bolts. These bolts secure the motor and motor adapter to the pump casing (figure 5.5D).
7. Separate the motor and motor adapter from the pump casing to expose the pump impeller (figure 5.5E). Remove the motor and motor



Pump motor

Figure 5.5B



Pump motor

Figure 5.5C



Typical casing bolt

Figure 5.5D

adapter from the unit and place on a workbench to continue the procedure.

8. Locate and remove the dust cap from motor end to expose slotted motor shaft. The motor shaft is free to rotate, but must be secured to remove the impeller. To secure the motor shaft, insert a flat bladed screw driver in slot to hold the shaft stationary (Figure 5.5F).
9. Locate and remove impeller locking screw (Figure 5.5G). Using a socket and ratchet, the impeller retaining screw can be removed. Once the retaining screw is removed, the impeller can be “unthreaded” from the motor shaft to expose the pump seal assembly.
10. Remove all seal parts (Figure 5.5H). Note seal component arrangement to facilitate reassembly.
11. Clean motor shaft and lubricate with a mild soap solution.
12. Install new stationary seal member in pump casing cavity (figure 5.5I). The operator must be certain the stationary seal member is fully squared and seated in cavity.
13. Slide the rotating member onto lubricated pump shaft (figure 5.5J). The operator must be certain not to damage or tear rubber bellows assembly.
14. Place the spring onto the rotating member.
15. Align the impeller, spring and rotating member before reinstalling the impeller (figure 5.5K). The operator must be certain the spring and rotating member are aligned before the impeller is fully tightened and the impeller retaining screw is reinstalled.
16. Clean pump casing, cavities, impeller and O-ring before reassembly.
17. Mate the motor and motor adapter to the pump casing. Reinstall the pump casing bolts.
18. Reconnect the motor power cord and leads.
19. Restore all cover panels as were removed.

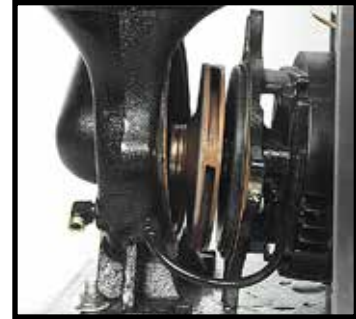

Impeller Figure 5.5E

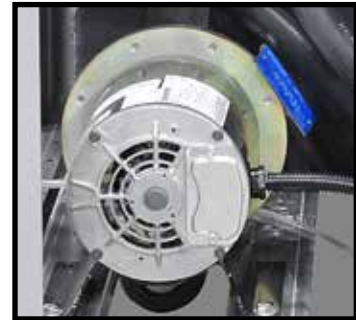

Motor shaft Figure 5.5F



Typical impeller Figure 5.5G



Seal components Figure 5.5H

- E. When the pump seal replacement procedure is complete, the operator may restart the unit according the **section 3**.



Stationary member Figure 5.5I



Stationary member Figure 5.5J



Seal members Figure 5.5K

5.6 CHECKING THE REFRIGERANT CHARGE

- A.** All standard chillers are manufactured with thermostatic expansion valves as the metering device to the evaporator.
- B.** All standard chillers have a refrigerant sight glass with a moisture indicator. To check the refrigerant charge under normal operating conditions:
1. Remove the plastic cap covering the sight glass.
 2. Start the chiller and allow system pressures and temperatures to stabilize.
 3. With the unit operating at 100% capacity (not in the “capacity control” mode) the sight glass should appear clear with no foam or bubbles evident. If foam or bubbles are evident, the chiller has suffered from a loss of refrigerant and should be checked by a qualified refrigeration technician.
 4. The “dot” in the middle of the sight glass is the moisture indicator. It should appear green at all times. A white or yellow color indicates moisture has invaded the refrigeration system, which is detrimental to the life of the compressor. The filter-drier should be replaced by a qualified refrigeration technician.



Sight Glass

5.7 PROPER CLEANING PROCEDURE FOR BRAZED PLATE EVAPORATORS

- A.** The brazed plate evaporator is made of stamped stainless steel plates, furnace brazed together with copper based joints. The complex geometry of the flow passages promotes turbulent flow which gives high efficiency and reduces fouling by mineral deposits. Large solids such as plastic pellets or chunks of mineral deposits will collect at the water inlet port at the evaporator and restrict flow through some of the passages. If this possibility exists, the Manufacturer recommends filters or strainers be added to the “from process” line. If the evaporator becomes fouled there are a couple of methods for cleaning.
- B.** To begin, remove the piping to the “water in” port at the evaporator. Remove any solids that have collected at this point. Then back flush the evaporator to remove any solids that may be trapped between the plates (see back flush procedure below). If there are mineral deposits adhered to the plates, the evaporator must be back flushed with a mild acid solution (5% phosphoric or 5% oxalic acid is recommended.) After cleaning rinse with clear water before returning to service. Continue with step C on the next page.
- C. Back flushing procedure:**
1. Turn off all power to the machine. For chillers with a reservoir tank, drain the tank to below the evaporator outlet. For chillers without a reservoir tank, drain total unit.



Evaporator

2. Connect a water supply hose to the evaporator water outlet. If acid cleaning, connect the discharge hose from the acid pump to the evaporator outlet port.
3. Connect a hose to the evaporator water supply port and to an appropriate containment vessel. If acid cleaning, connect the evaporator water inlet port to an acid solution reservoir tank. Dispose of all back flush fluid according to local codes.
4. The cleaning fluid source should have at least 20 psi available. If acid cleaning, follow the instructions supplied with the acid solution carefully.
5. When the procedure is complete, reinstall all water lines to original factory orientation. Restart the unit and check for proper operation.
6. **Note:** This procedure is not normal maintenance. Maintaining proper water quality and filtration will minimize the need to back flush the evaporator.

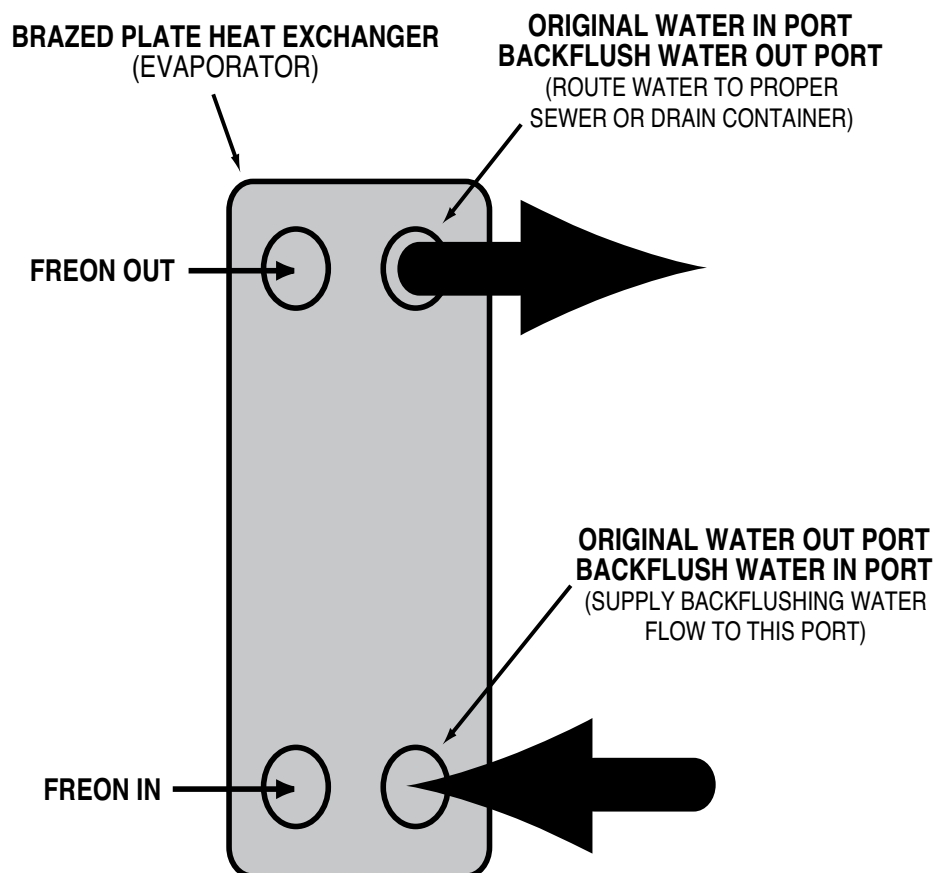

6.0 Components

- 6.1** Water System
- 6.2** Refrigeration System
- 6.3** Options



6.1 WATER SYSTEM

- A. MOTOR/PUMP ASSEMBLY:** The motor/pump assembly circulates chilled fluid to the process loop. The pump assembly is built of total stainless steel to maintain water quality.
- B. RESERVOIR.** The vented reservoir is sized for the chiller application to support the flow rate. The reservoir provides a stable water temperature under varying load conditions.



Coolant Pump



Reservoir

6.2 REFRIGERATION SYSTEM

- A. COMPRESSOR:** Compressors take low pressure/low temperature refrigerant gas and compress the gas into high pressure/high temperature gas.
- B. AIR COOLED CONDENSER:** The air cooled condenser removes heat from the compressed refrigerant gas. The action causes the gas to “condense” into a liquid state still under high pressure. Air flow across the condenser is achieved via a motor driven fan assembly or centrifugal blower.
- C. WATER COOLED CONDENSER:** The water cooled condenser removes heat from the compressed refrigerant gas. As the heat is removed, the gas “condenses” into a liquid state, still under high pressure. Water regulator valves are used on all models to control the refrigerant head pressure by modulating the condenser water flow.
- D. FILTER-DRIER:** The filter-drier removes contaminants and moisture from the liquid refrigerant.
- E. REFRIGERANT SIGHT GLASS:** The refrigerant sight glass indicates refrigerant charge and moisture content.



Compressor



Typical Air-Cooled Condenser

- Full refrigerant charge is determined by a clear liquid flow.
- Bubbles indicate low refrigerant.
- Moisture content is indicated by the color of the element.
- Element color is normally green.



Typical Water-Cooled Condenser



Typical Filter Drier

- If the color of the element is chartreuse or yellow, the system has been contaminated with moisture. In such case, the filter-drier must be replaced. The replacement of the filter-drier must be completed by a qualified refrigerant service technician.



Typical Refrigerant Sight Glass

- F. EXPANSION VALVE:** The expansion valve throttles flow of refrigerant liquid into the evaporator and creates a pressure drop in the refrigerant system that allows the liquid refrigerant to “boil off” inside the evaporator.



Typical Expansion Valve

- G. EVAPORATOR:** The evaporator is a brazed plate heat exchanger where the refrigerant liquid is allowed to evaporate (boil off) to absorb heat (BTU) from the process fluid. As the heat is absorbed, the process fluid is chilled (figure 6.2G).

- H. CAPACITY CONTROL:** The chiller is equipped with a capacity control feature. The capacity control feature matches the chiller capacity to the cooling load to provide temperature control and to prevent short cycling of the compressor. Units with digital scroll compressors (CGD) use a solenoid valve to unload the compressor to as low as about 20% capacity. Units without a digital scroll compressor use a hot gas bypass solenoid valve to reduce the chiller capacity to about 50%.



Typical Brazed Plate Evaporator

- I. Liquid receiver:** (optional feature) located after the condenser, this component receives and stores liquid refrigerant leaving the condenser.
- K. Service valves:** These valves are located throughout the system. Only a qualified refrigeration service technician shall operate these valves.



Typical optional automatic low flow bypass valve.

6.3 UNIT OPTIONS

- A. LOW FLOW BYPASS:** If your process will experience lower than design flow rates or intermittent flow, a low flow bypass valve will be required.
- B. OVERHEAD PIPING KIT:** To avoid reservoir overflow during shut down periods from overhead piping, The Manufacturer recommends the installation of an overhead piping kit. The overhead piping kit consists of a full line size solenoid valve in the “from process” line that is interlocked with the pump and a check valve (single direction valve) in the “to process” line.



Typical overhead piping kit. Shown with optional process line shut off valves. Process line shut off valves are also shown in this photo.

C. PROCESS LINE SHUT OFF VALVES: These valves are full size ball valves installed on the “to” and “from” process lines at the exit of the chiller. These valves can be used to adjust the process flow rate and to shut off the flow rate to isolate the chiller.

D. E-STOP BUTTON: The Emergency stop button is a mushroom type button which will shut down all chiller operations when engaged.



Emergency stop button. Shown with Power On light.

E. NON-FUSED OR FUSED DISCONNECT SWITCH: On board disconnect switch provides a convenient location for isolating all electric power to the chiller.



Non-fused disconnect.

F. AUDIBLE AND OR VISUAL ALARM: Alarms indicate out-of-spec operating conditions. There are two types of alarms:

Audible Alarm:

A simple buzzer alarm emits a loud alarm.

Visual Alarm:

Emits an audible sound and flashes a beacon.



Typical Alarm Beacon.

G. CONDENSER SCREEN: Optional for air-cooled models only. The condenser screen is a filter for the air-cooled condenser to prevent air borne solids and debris from clogging the condenser.



Typical Condenser Screen.

H. REVERSE FLOW PIPING: Reverse flow chillers are designed specifically for open circuit processes. Notice that the flow circuit remains basically the same, but the process acts as the chiller reservoir, and gravity returns water to the pump suction. System water make-up and level control is accomplished externally at the process since the chiller contains no reservoir.

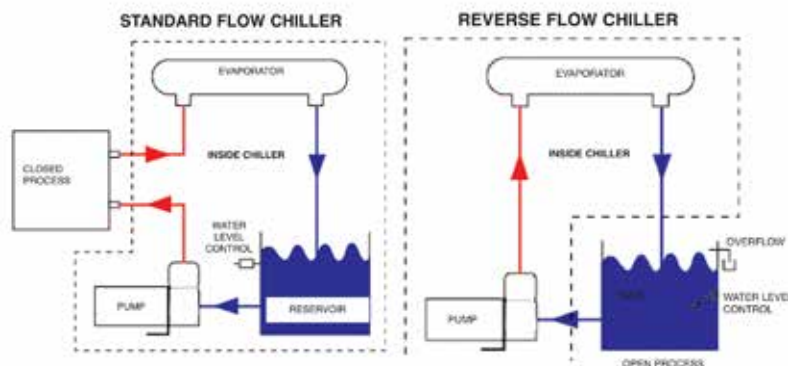

Note - Items shown within the dotted borders represent components located inside the chiller.

7.0 RELATED DRAWINGS

- 7.1 Mechanical Schematic : Water-Cooled : 5 - 10 tons
- 7.2 Mechanical Schematic : Water-Cooled : 15 - 40 tons
- 7.3 Mechanical Schematic : Air-Cooled : 5 - 10 tons with Propeller Fans
- 7.4 Mechanical Schematic : Air-Cooled : 15 - 30 tons and 5 - 20 ton Models with
Optional Centrifugal Blower
- 7.5 Electrical Drawing : Air-Cooled
- 7.6 Electrical Drawing : Water-Cooled
- 7.7 Physical Drawing : Water-Cooled : 5 - 10 Ton
- 7.8 Duct Schematic for Air-cooled Chillers



7.1 MECHANICAL SCHEMATIC : WATER-COOLED : 5 - 10 TON MODELS

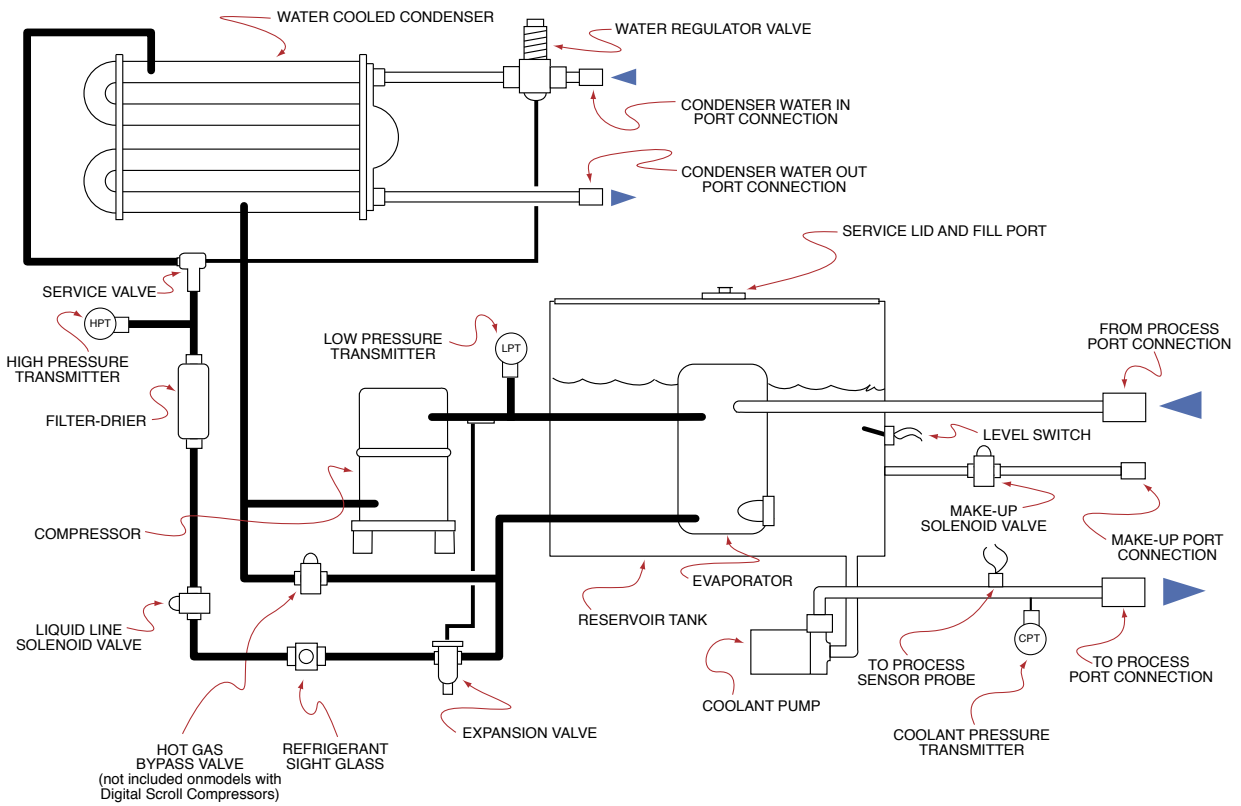

7.2 MECHANICAL SCHEMATIC : WATER-COOLED : 15 - 40 TON MODELS

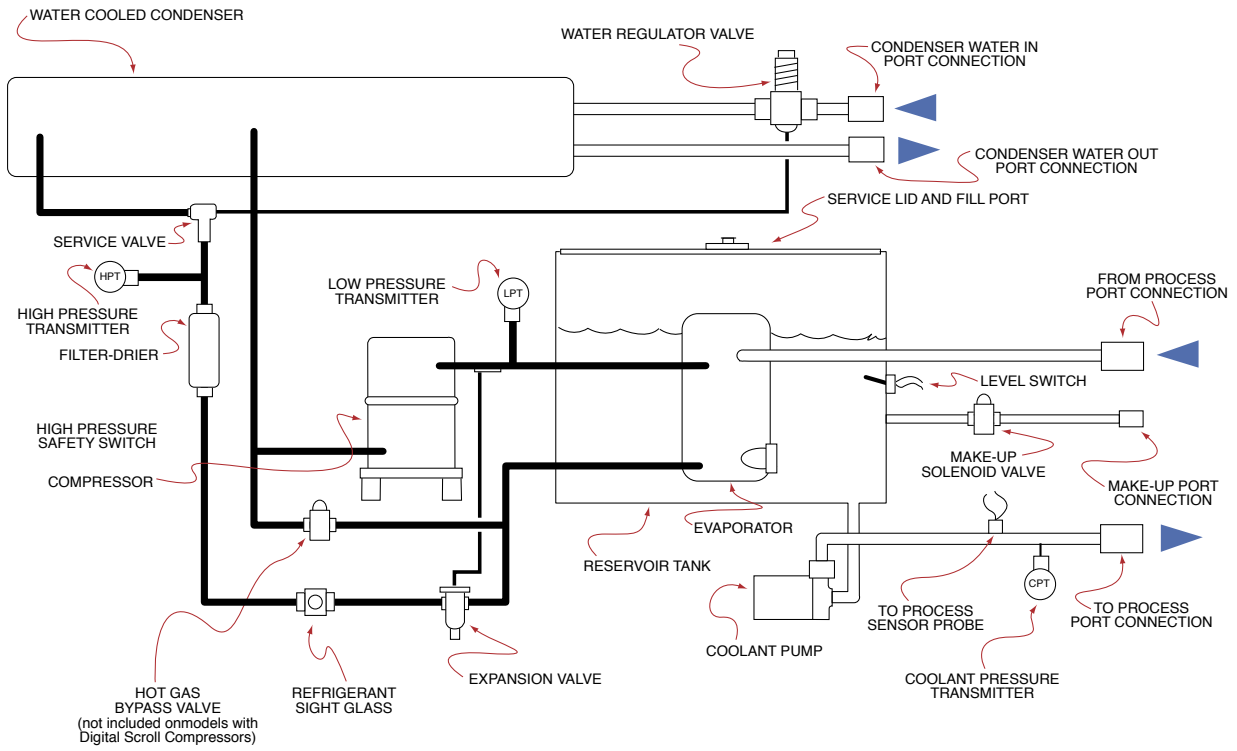

7.3 MECHANICAL SCHEMATIC : AIR-COOLED : 5 - 20 TON MODELS WITH PROPELLER FANS

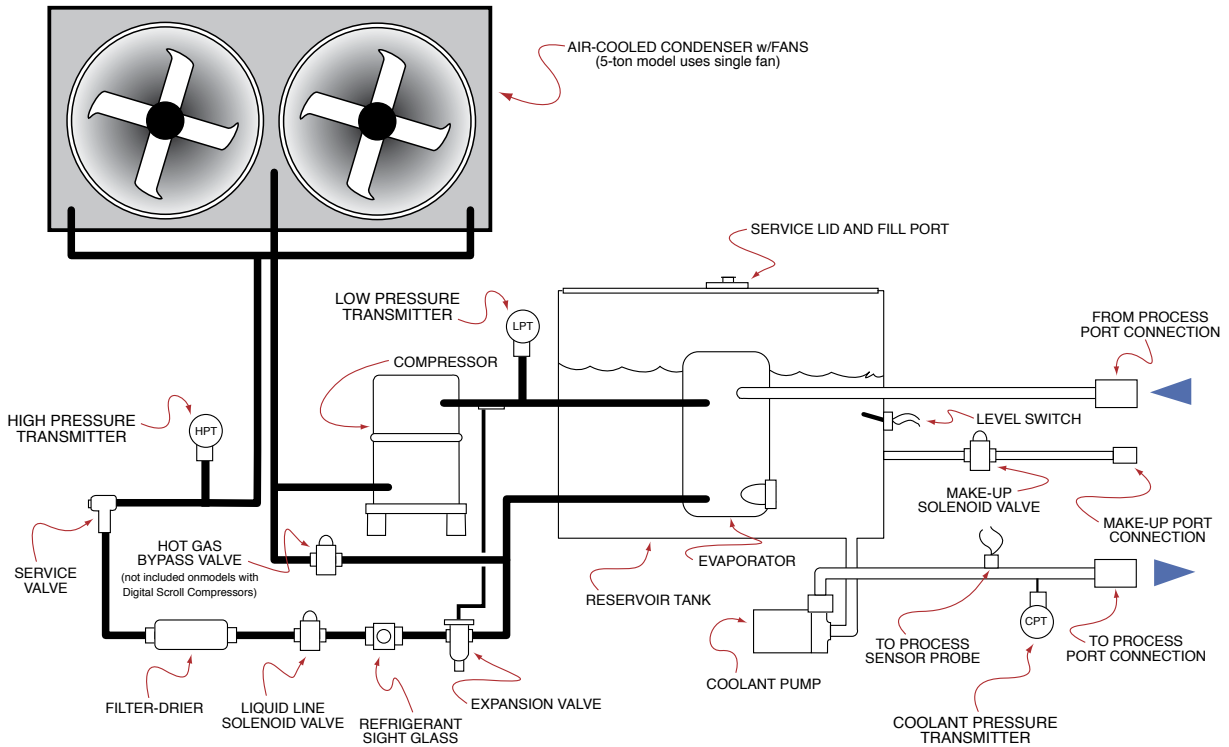

7.4 MECHANICAL SCHEMATIC : AIR-COOLED : 25 - 30 TON MODELS AND 5 - 20 TON MODELS WITH OPTIONAL CENTRIFUGAL BLOWER

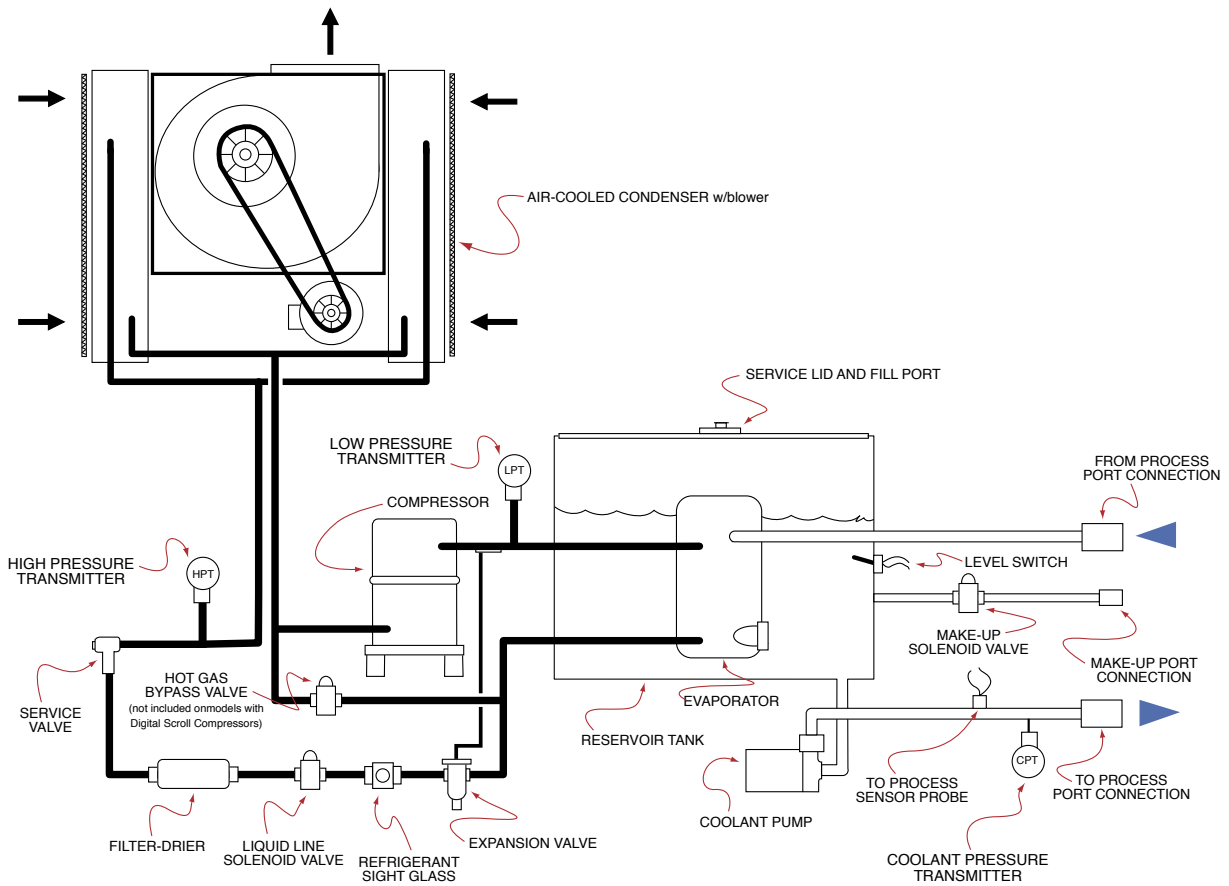

7.5 TYPICAL ELECTRICAL DRAWING - AIR COOLED

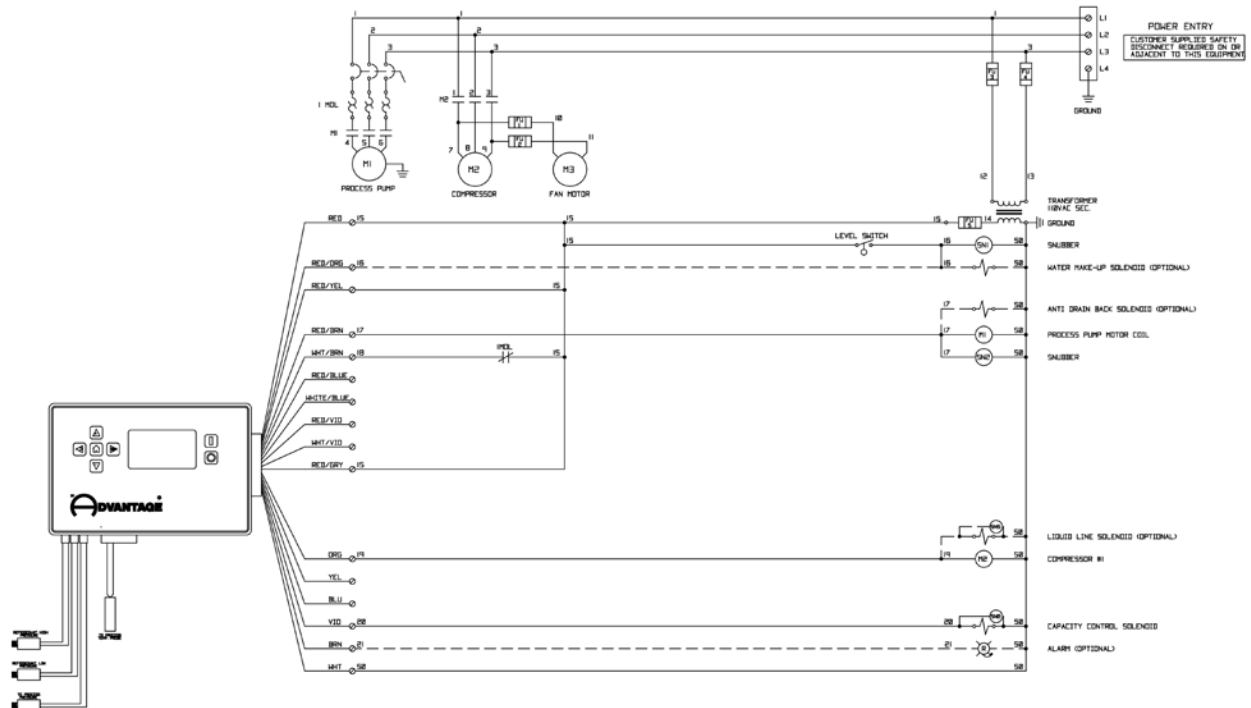

Electrical schematic is presented for illustration purposes only.
For exact details, consult the electrical drawing supplied with your machine.



7.6 TYPICAL ELECTRICAL DRAWING - WATER COOLED

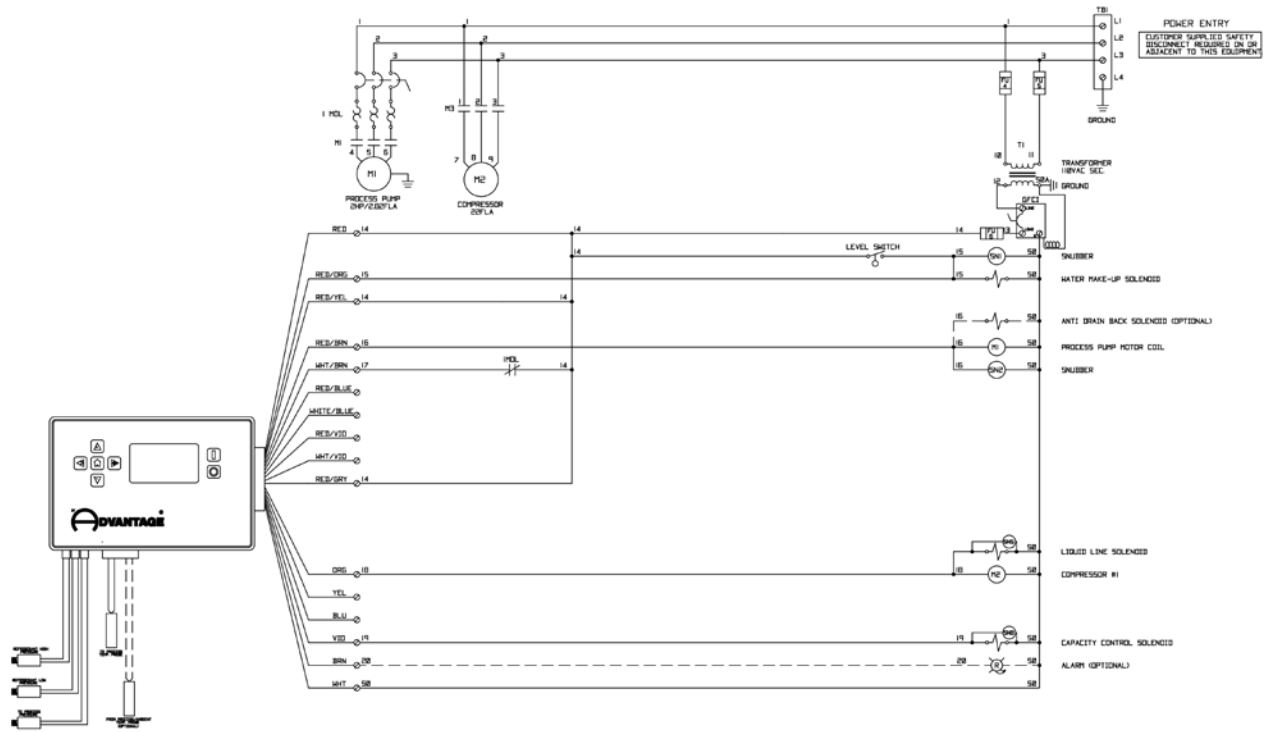

This electrical is shown with optional UL panel components. The GFCI would not be standard.

Electrical schematic is presented for illustration purposes only.
For exact details, consult the electrical drawing supplied with your machine.

7.7 TYPICAL PHYSICAL - WATER COOLED : 5 - 10 TON

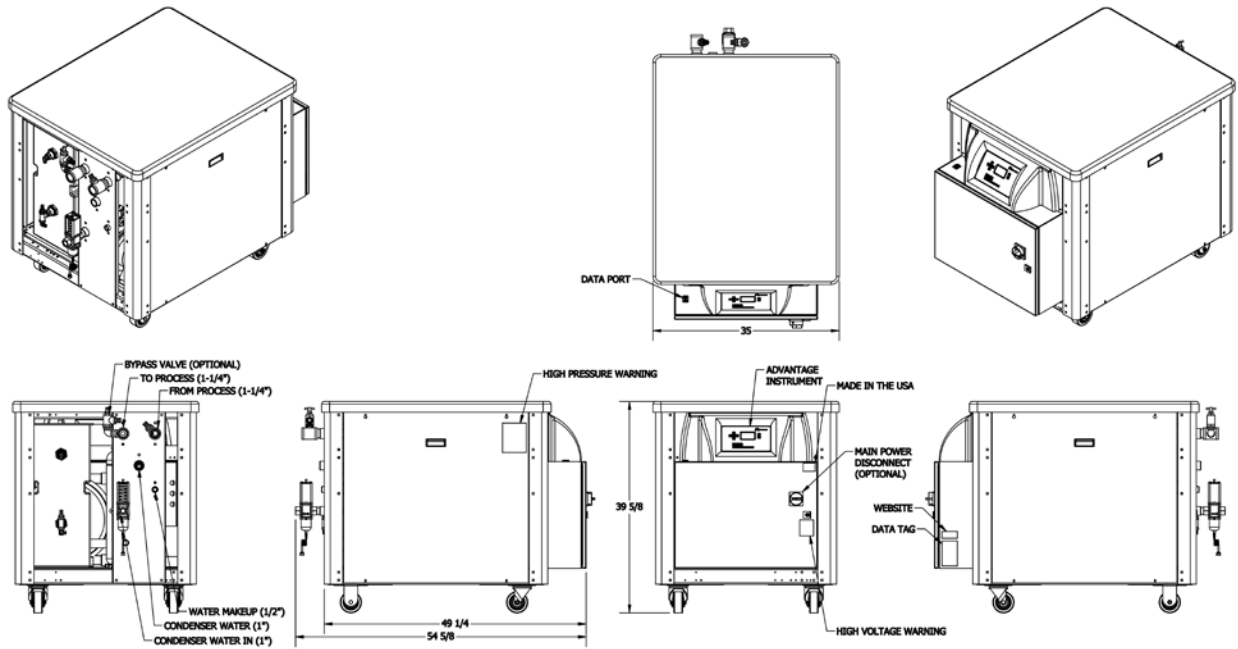

The Physical Drawing is presented for illustration purposes only.
For exact details, consult the Manufacturer.



7.8 DUCT SCHEMATIC FOR AIR-COOLED CHILLERS

- A. For models equipped with centrifugal blower. Models with equipped with fans can not be ducted.

NOTE: THIS DRAWING IS FOR EXPLANATION PURPOSES ONLY, NOT FOR CONSTRUCTION PURPOSES

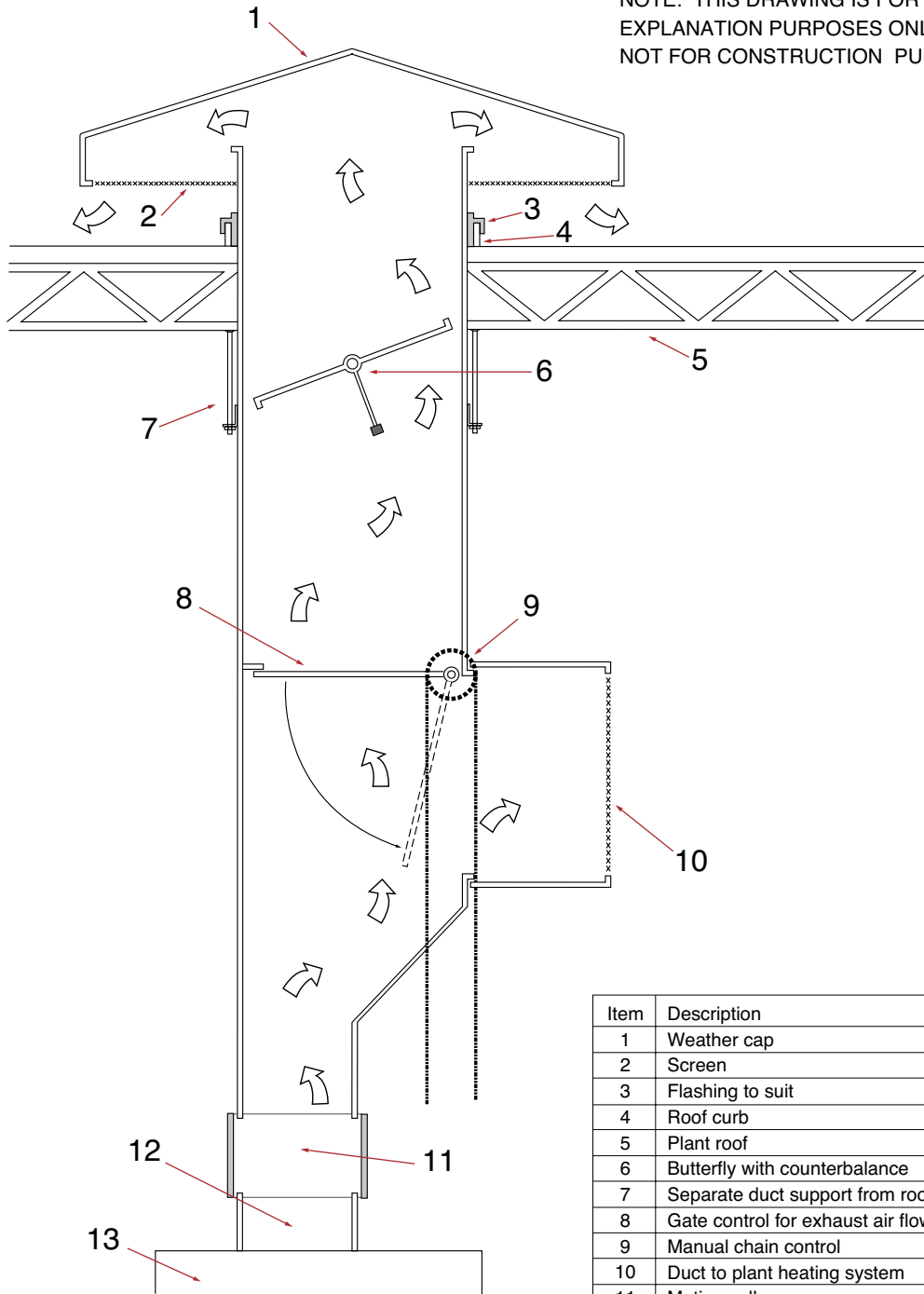

Item	Description
1	Weather cap
2	Screen
3	Flashing to suit
4	Roof curb
5	Plant roof
6	Butterfly with counterbalance
7	Separate duct support from roof
8	Gate control for exhaust air flow
9	Manual chain control
10	Duct to plant heating system
11	Mating collar
12	Chiller air exhaust port
13	Air cooled chiller with blower

THIS PAGE INTENTIONALLY BLANK

8.0 APPENDIX

- 8.1** Operations Below 48°F
- 8.2** Operating Below 48°F Fluid or 38°F Ambient
- 8.3** Refrigerant Pressure-Temperature Chart
- 8.4** Inhibited Propylene Glycol
- 8.5** Chiller Capacity and Derate Chart
- 8.6** Probe Calibration : CG Instrument
- 8.7** Status Indicators : CG Instrument
- 8.8** Water Quality
- 8.9** Modbus Registers
- 8.10** Remote Start and Auto Start Feature Configuration



8.1 OPERATIONS BELOW 48°F FLUID OR 38°F AMBIENT

- A. The chiller is never to be operated below 48°F leaving water temperature without several precautionary measures. All controls are factory adjusted for 48°F and above operations.
- B. Before readjusting the protective devices, a satisfactory antifreeze solution must be substituted for the recirculating chilled water. This mixture will consist of inhibited propylene glycol and water. Do not substitute an inhibited propylene glycol and water solution with common automotive type antifreeze. The chart on the next page outlines the glycol percentages at various water temperatures.
- C. Fluid must be tested with a refractometer to verify proper glycol percentages for freeze protection. The ratio shall be according to the chart below. Too much glycol can cause capacity and control problems.
- D. **DO NOT USE AUTOMOTIVE TYPE ANTI-FREEZE.**
- E. **Once a satisfactory antifreeze solution is in place the protective devices may be adjusted and the control instrument can be unlocked to allow operation below 48°F.**

Refrigerant Low Pressure Switch Cut-Out & Cut-In Settings

Operating or Ambient Temperature	Glycol	Freeze Point	Cut Out Temp		R22		R134A		R410A	
			Cut Out Temp	Cut In Temp	Cut-Out	Cut-In	Cut-Out	Cut-In	Cut-Out	Cut-In
48° - 70°F	0%	32°F	32°F	36°F - 39°F	58#	63#	28#	33#	102#	111#
25° - 47°F	30%	10°F	10°F	15°F - 18°F	33#	38#	12#	17#	63#	72#
10° - 24°F	40%	-5°F	-5°F	0°F - 7°F	20#	25#	4#	9#	43#	52#

Operating or Ambient Temperature	Glycol	Freeze Point	Cut Out Temp		R404A		R407C	
			Cut Out Temp	Cut In Temp	Cut-Out	Cut-In	Cut-Out	Cut-In
48° - 70°F	0%	32°F	32°F	36°F - 39°F	72#	79#	52#	58#
25° - 47°F	30%	10°F	10°F	15°F - 18°F	44#	49#	28#	34#
10° - 24°F	40%	-5°F	-5°F	0°F - 7°F	29#	34#	16#	22#

- F. The unit is equipped with an adjustable low pressure switch. Adjustments are made on screen. Go to Main Menu -> Machine -> LP Cut Out and Main Menu -> Machine -> LP Cut In to adjust the low pressure switch according to the specifications in the chart below.

Never lower the cut out setting on the adjustable low pressure switch without adding glycol to the circulating system. Evaporator damage will result and this damage is not covered by the factory warranty.

- G. Once all safety provisions are made, the temperature control set point may now be lowered to the desired operating temperature.
- H. **WARNING:** do not use any type or brand of automotive antifreeze. Automotive antifreeze contains corrosion inhibitors - silicates - designed for compatibility with the materials in automotive engines. Unfortunately, silicates can gel and cause deposits to foul and insulate heat exchanger surfaces. In your chilling system that can mean higher energy costs, high pumping costs, and possibly even shut downs for system cleaning. We recommend the use of DowFrost or Monsanto DFS-1.



8.2 REFRIGERANT PRESSURE-TEMPERATURE CHART

Refrigerant Pressure Temperature Chart

Temperature		Refrigerant					Temperature		Refrigerant				
°F	°C	R-22	R-410a	R-407c	R-134a	R-404a	°F	°C	R-22	R-410a	R-407c	R-134a	R-404a
-60	-51.1	<i>11.9</i>	<i>0.9</i>	<i>16.0</i>	<i>21.6</i>	-	27	-2.8	51.2	91.6	44.7	23.7	66.2
-55	-48.3	<i>9.2</i>	1.8	<i>13.7</i>	<i>20.2</i>	-	28	-2.2	52.4	93.5	45.9	24.5	67.7
-50	-45.6	<i>6.1</i>	4.3	<i>11.1</i>	<i>18.6</i>	-	29	-1.7	53.7	95.5	47.1	25.3	69.2
-45	-42.8	<i>2.7</i>	7.0	<i>8.1</i>	<i>16.7</i>	-	30	-1.1	54.9	97.5	48.4	26.1	70.7
-40	-40.0	0.6	10.1	<i>4.8</i>	<i>14.7</i>	4.9	31	-0.6	56.2	99.5	49.6	26.9	72.1
-35	-37.2	2.6	13.5	<i>1.1</i>	<i>12.3</i>	7.5	32	0.0	57.5	101.6	50.9	27.8	73.8
-30	-34.4	4.9	17.2	1.5	<i>9.7</i>	10.3	33	0.6	58.8	103.6	52.1	28.6	75.3
-25	-31.7	7.5	21.4	3.7	<i>6.8</i>	13.5	34	1.1	60.2	105.7	53.4	29.5	76.9
-20	-28.9	10.2	25.9	6.2	<i>3.6</i>	16.8	35	1.7	61.5	107.9	54.8	30.4	78.5
-18	-27.8	11.4	27.8	7.2	<i>2.2</i>	18.3	36	2.2	62.9	110.0	56.1	31.3	80.2
-16	-26.7	12.6	29.7	8.4	<i>0.7</i>	19.8	37	2.8	64.3	112.2	57.5	32.2	81.7
-14	-25.6	13.9	31.8	9.5	0.4	21.3	38	3.3	65.7	114.4	58.9	33.1	83.5
-12	-24.4	15.2	33.9	10.7	1.2	22.9	39	3.9	67.1	116.7	60.3	34.1	85.2
-10	-23.3	16.5	36.1	11.9	2.0	24.6	40	4.4	68.6	118.9	61.7	35.0	86.9
-8	-22.2	17.9	38.4	13.2	2.8	26.3	41	5.0	70.0	121.2	63.1	36.0	88.6
-6	-21.1	19.4	40.7	14.6	3.7	28.0	42	5.6	71.5	123.6	64.6	37.0	90.4
-4	-20.0	20.9	43.1	15.9	4.6	29.8	43	6.1	73.0	125.9	66.1	38.0	92.2
-2	-18.9	22.4	45.6	17.4	5.5	31.7	44	6.7	74.5	128.3	67.6	39.0	94.0
0	-17.8	24.0	48.2	18.9	6.5	33.7	45	7.2	76.1	130.7	69.1	40.0	95.8
1	-17.2	24.8	49.5	19.6	7.0	34.7	46	7.8	77.6	133.2	70.6	41.1	97.6
2	-16.7	25.7	50.9	20.4	7.5	35.7	47	8.3	79.2	135.6	72.2	42.2	99.5
3	-16.1	26.5	52.2	21.2	8.0	36.7	48	8.9	80.8	138.2	73.8	43.2	101.4
4	-15.6	27.4	53.6	22.0	8.6	37.7	49	9.4	82.4	140.7	75.4	44.3	103.3
5	-15.0	28.3	55.0	22.8	9.1	38.8	50	10.0	84.1	143.3	77.1	45.4	105.3
6	-14.4	29.1	56.4	23.7	9.7	39.8	55	12.8	92.6	156.6	106.0	51.2	115.3
7	-13.9	30.0	57.9	24.5	10.2	40.9	60	15.6	101.6	170.7	116.2	57.4	126.0
8	-13.3	31.0	59.3	25.4	10.8	42.0	65	18.3	111.3	185.7	127.0	64.0	137.4
9	-12.8	31.9	60.8	26.2	11.4	43.1	70	21.1	121.5	201.5	138.5	71.1	149.3
10	-12.2	32.8	62.3	27.1	12.0	44.3	75	23.9	132.2	218.2	150.6	78.6	161.9
11	-11.7	33.8	63.9	28.0	12.6	45.4	80	26.7	143.7	235.9	163.5	86.7	175.4
12	-11.1	34.8	65.4	29.0	13.2	46.6	85	29.4	155.7	254.6	177.0	95.2	189.6
13	-10.6	35.8	67.0	29.9	13.8	47.8	90	32.2	168.4	274.3	191.3	104.3	204.5
14	-10.0	36.8	68.6	30.9	14.4	49.0	95	35.0	181.9	295.0	206.4	113.9	220.2
15	-9.4	37.8	70.2	31.8	15.1	50.2	100	37.8	196.0	316.9	222.3	124.1	236.8
16	-8.9	38.8	71.9	32.8	15.7	51.5	105	40.6	210.8	339.9	239.0	134.9	254.2
17	-8.3	39.9	73.5	33.8	16.4	52.7	110	43.3	226.4	364.1	256.5	146.3	272.5
18	-7.8	40.9	75.2	34.8	17.1	54.0	115	46.1	242.8	389.6	274.9	158.4	291.9
19	-7.2	42.0	77.0	35.9	17.7	55.3	120	48.9	260.0	416.4	294.2	171.1	312.1
20	-6.7	43.1	78.7	36.9	18.4	56.6	125	51.7	278.1	444.5	314.5	184.5	333.4
21	-6.1	44.2	80.5	38.0	19.2	57.9	130	54.4	297.0	474.0	335.7	198.7	355.6
22	-5.6	45.3	82.3	39.1	19.9	59.3	135	57.2	316.7	505.0	357.8	213.5	379.1
23	-5.0	46.5	84.1	40.2	20.6	60.6	140	60.0	337.4	537.6	380.9	229.2	403.7
24	-4.4	47.6	85.9	41.3	21.4	62.0	145	62.8	359.1	571.7	405.1	245.6	429.6
25	-3.9	48.8	87.8	42.4	22.1	63.4	150	65.6	381.7	607.6	430.3	262.8	456.8
26	-3.3	50.0	89.7	43.6	22.9	64.8	155	68.3	405.4	645.2	456.6	281.0	484.8

Italics indicates vacuum (inches of mercury)

Standard font indicates pressure (pounds per inch gauge)



8.3 INHIBITED PROPYLENE GLYCOL

- A.** To operate liquid chillers below 48°F, it is necessary to add **inhibited propylene glycol** to the circulating system to lower the freeze point and prevent damage to the cooling system. Inhibited propylene glycol contains corrosion inhibitors which are compatible with most industrial heat transfer surfaces. Inhibited propylene glycol is manufactured by:
- Dow Chemical - “DowFrost” (1-800-258-2436)
 - Monsanto “Therminol FS” (1-800-459-2665)
- B.** Automotive anti-freeze must never be used in industrial heat transfer applications. Automotive anti-freeze contains silicate type corrosion inhibitors designed to be compatible with automotive components. In an industrial application, the silicates will form a gel on the heat transfer surface which will result in substantial reduction in cooling capacity and is virtually impossible to remove.

8.4 CHILLER CAPACITY AND DERATE CHART

Standard chiller rating is at 50°F. For all other temperature settings, output tonnage is altered as follows:

OUTPUT TEMPERATURE °F	FULL AVAILABLE % CAPACITY
60	105%
50	100%
45	90%
40	80%
35	70%
30	60%
25	50%
20	40%

NOTES:

If operation of the chiller at less than 48°F is required, an inhibited propylene glycol solution is required.

Do not operate the chiller below 20F fluid setpoint unless the unit has been specifically configured for this duty.

Ambient conditions affect air cooled chiller operation and capacity. Standard rating is at 95°F entering air temperature. For ambient air conditions greater than 95°F, chiller derating will occur. For ambients over 95°F consult factory.



8.5 STANDARD CG INSTRUMENT SETTINGS

- A. Caution: See section 8.1 for proper settings based on your fluid set point temperature.

Adjustable Low Pressure Cut Out Range

- 9 PSI to 150 PSI
-

Adjustable Low Pressure Cut In Range

- 19 PSI to 150 PSI
-

Adjustable High Pressure Cut Out Range

- 225 PSI to 580 PSI
-



8.6 PROBE CALIBRATION : CG Instrument

A. Equipment Needed:

1. Potentiometer adjustment tool / flat-blade screw driver (tip width of 0.050" or less works best)
2. Temperature reference (ice water bath)
3. 1/2" plug
4. Digital thermometer
5. Screwdriver (chassis disassembly)

B. Setup:

1. Disengage process operations according to the procedure outlined in the unit manual. The operator must be certain all system pressure is relieved and unit pressure gauges read "0".
2. Following all lock-out-tag-out procedures disengage main power supply.
3. Remove the "to process" temperature probe and insert a 1/2" plug in its place.
4. Prepare an ice bath (a cup of water with lots of ice). You should place a digital thermometer in the ice bath to read the temperature of the bath. Place the probe in the ice bath.

C. Procedure:

1. Restart the instrument according to the procedures outlined in the unit manual.
2. Reduce the unit's setpoint to its lowest setting.
3. The "to process" temperature on the display should equal the temperature of the ice bath as indicated by the digital thermometer. If not, change the calibration.
4. The calibration potentiometer is located on the top of the CPU board. To access it, open the electrical cabinet panel door. Caution must be employed when the electrical panel door is open since power is applied to unit.
5. Locate the "to process" calibration potentiometer using Figure 1 as a guide. Use the small screwdriver to turn the potentiometer.
6. Adjust the potentiometer until the "to process" temperature on the display equals the temperature of the ice bath.
7. When the two temperatures are equal, the calibration procedure is complete.
NOTE: the optional "from process" probe has its own calibration potentiometer.



If calibration of this probe is required, repeat the setup and calibration procedure with the “from process” probe. A from process probe may not be included with your chiller.

8. Stop the unit following the shutdown procedure described in the manual and place all process probes back in the unit to return to normal operation.

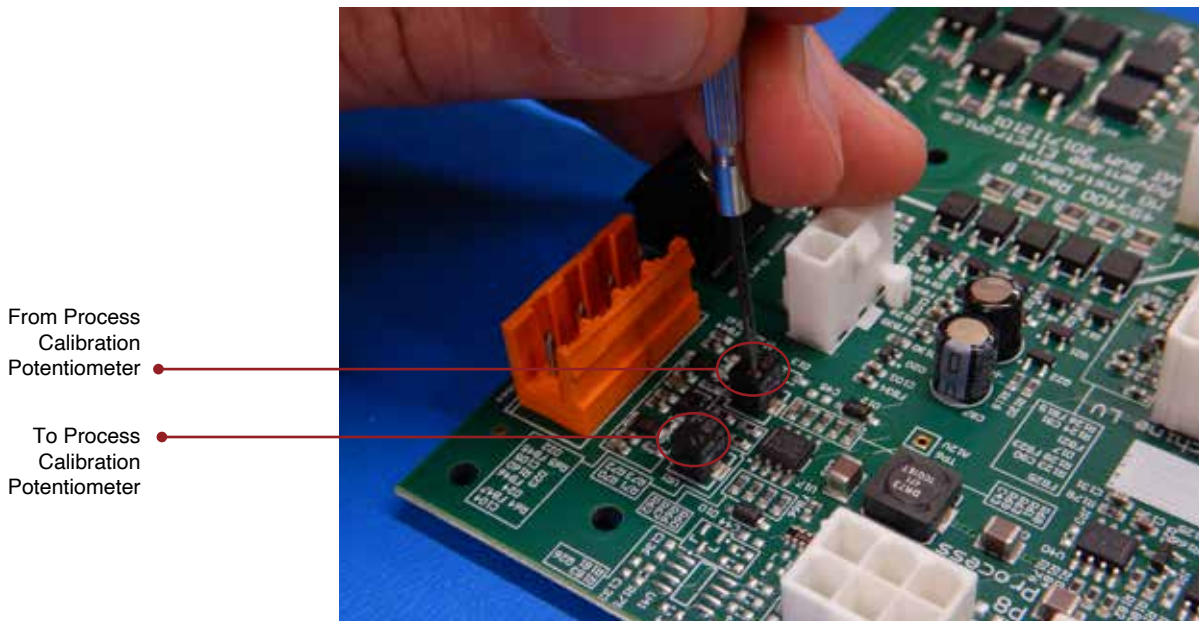

8.7 STATUS INDICATORS : CG INSTRUMENT

- A. The control instrument is configured at the Factory for the type and number of compressors and type of capacity unloading mechanism.
- B. Shown below are possible Status Indicators displays for various compressor and capacity unloading set ups.

Typical display for chillers with a single compressor (digital scroll or scroll) and digital or hot gas bypass capacity unloading.

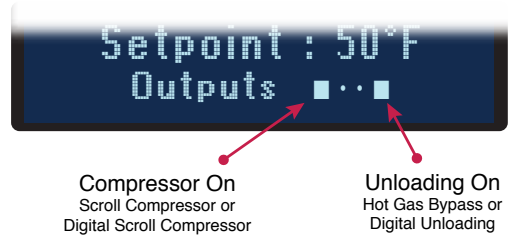

Typical display for chillers with two compressors (digital scroll or scroll) and digital or hot gas bypass capacity unloading.

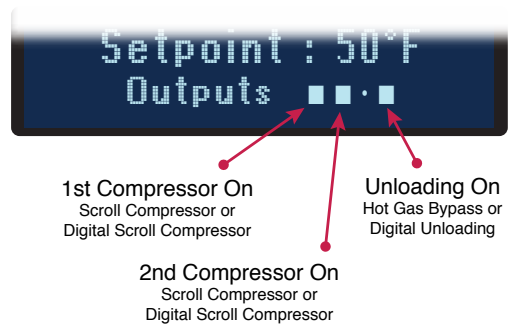

Typical display for chillers with a discus compressor and a capacity unloader.



Typical display for chillers with a screw compressor showing capacity at 50% and 75%. The fourth indicator will pulse on for 10 seconds then off for 10 seconds indicating proper compressor operation.

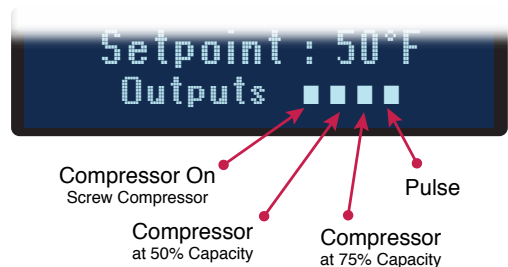

8.8 WATER QUALITY

- A.** Lack of as well as improper water treatment can damage to your equipment. The equipment owner is responsible to prevent equipment damage from foreign material or inadequate water treatment. The services of a competent water treatment specialist should be obtained and his recommendations followed. For small systems, a local swimming pool supply is an excellent source of analysis service and chemical supplies. An alternative is the addition of 20% inhibited propylene glycol. This will inhibit corrosion, algae growth and prevent accidental freeze ups.

Sources For Inhibited Propylene Glycol

- Therminol FS Monsanto Chemical 1-800-459-2665
- Dowfrost Dow Chemical 1-800-447-4369

FREEZING POINTS FOR WATER/PROPYLENE GLYCOL SOLUTIONS

PERCENTAGE OF GLYCOL* WATER		FREEZE POINT °F °C	
0	100	32	0
10	90	25	-3.9
20	80	10	-12.2
30	70	0	-17.8
40	60	-10	-23.3
50	50	-30	-34.4
60	40	-60	-51.4

*Propylene Glycol
Note: Glycol freeze point must be 25°F below lowest setpoint.

- B.** The following are guidelines specific to chillers with an internal circulation pump and fluid reservoirs.
- C.** Long term performance of your chiller will be adversely affect by poor water conditions. The three major problems water treatment must address are:

1. Scaling

- a.** Scaling of the heat transfer surfaces due to minerals can be minimized by proper treatment and filtering of the make-up water. A good quality of water must be used.
- b.** The recommended purity levels are:
- | | |
|-----------|------------|
| Chlorides | 25 ppm max |
| Sulfates | 25 ppm max |
| Calcium | 50 ppm max |
| Magnesium | 50 ppm max |
| PH level | 8 to 10 |
- c.** Although not mandatory, distilled water would be an excellent choice for filling the system.



2. Corrosion

1. Corrosion is usually the result of acidic water (improper PH control). This can be controlled by proper chemical treatment.



3. Algae

1. Algae (organism growth) can be controlled by the proper use of chemical treatment.

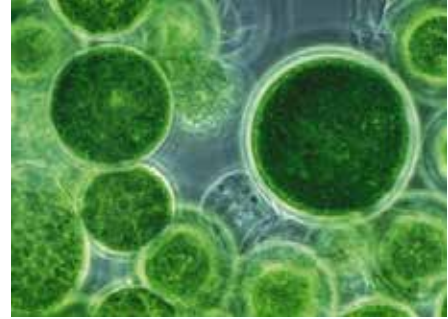

8.9 MODBUS REGISTERS

	Register	Coil	Use	Range	Units	Notes	* Low water level is defined but not implemented and will never trigger																		
Temperature Setpoint	1		R/W	0 - 250	F																				
Reserved	2																								
Temperature High Alarm	3		R/W	0 - 50	F	Deviation Value																			
Temperature Low Alarm	4		R/W	0 - 50	F	Deviation Value																			
Low Flow Alarm	5		R/W	0 - 255	GPM	Absolute Value																			
To Process Temperature	6		R	0 - 255	F																				
From Process Temperature	7		R	0 - 255	F																				
Flow	8				GPM																				
Process Status	9	1 thru 16	R				Bit 15	Bit 14	Bit 13	Bit 12	Bit 11	Bit 10	Bit 9	Bit 8	Bit 7	Bit 6	Bit 5	Bit 4	Bit 3	Bit 2	Bit 1	Bit 0			
													Low Flow				Low Temp	Hi Temp	Alarm Machine	Alarm Process	Alarm	0			
Machine Status 1	10	17 thru 32	R				Bit 15	Bit 14	Bit 13	Bit 12	Bit 11	Bit 10	Bit 9	Bit 8	Bit 7	Bit 6	Bit 5	Bit 4	Bit 3	Bit 2	Bit 1	Bit 0			
								Phase Wrong		MOL Evap Pump			Low Flow		Low Ref Pressure	High Ref Pressure	Low Temp		Alarm Machine	Alarm Process	Alarm	0			
Machine Status 2	11	33 thru 48	R				Bit 15	Bit 14	Bit 13	Bit 12	Bit 11	Bit 10	Bit 9	Bit 8	Bit 7	Bit 6	Bit 5	Bit 4	Bit 3	Bit 2	Bit 1	Bit 0			
																		Sensor Fail	Alarm Machine	Alarm Process	Alarm	0			
Machine Status 3	12	49 thru 64	R				Bit 15	Bit 14	Bit 13	Bit 12	Bit 11	Bit 10	Bit 9	Bit 8	Bit 7	Bit 6	Bit 5	Bit 4	Bit 3	Bit 2	Bit 1	Bit 0			
																			MOL Evap Pump	MOL Proc Pump	Low Water Level	Alarm Machine	Alarm Process	Alarm	0
	13	65 thru 80	R																						
	14	81 thru 96	R																						
	15	97 thru 112	R																						
Machine Control	16	113 thru 128	R/W				Bit 15	Bit 14	Bit 13	Bit 12	Bit 11	Bit 10	Bit 9	Bit 8	Bit 7	Bit 6	Bit 5	Bit 4	Bit 3	Bit 2	Bit 1	Bit 0			
																						Alarm Ack.	On/Off		
Reserved	17																								
Reserved	18																								
Reserved	19																								
Reserved	20																								
Reserved	21																								
Reserved	22																								
Status	23	257 thru 272					Bit 15	Bit 14	Bit 13	Bit 12	Bit 11	Bit 10	Bit 9	Bit 8	Bit 7	Bit 6	Bit 5	Bit 4	Bit 3	Bit 2	Bit 1	Bit 0			
							1	Reserved	Output 4	Output 3	Output 2	Output 1	Reserved	Reserved	1	Running	Comp. Overload	Low Oil Pressure	Reserved	High Ref. Pressure	Low Ref. Pressure	Low Water Flow			
Reserved	24																								
Reserved	25																								
Reserved	26																								
Reserved	27																								
Reserved	28																								
Low Refrig Suction Pressure	29		R		PSI																				
High Refrig Discharge Pressure	30		R		PSI																				
To Process Water	31		R		PSI																				
Reserved	32		R																						
Reserved	33		R																						
Reserved	34		R																						
Reserved	35		R																						
Reserved	36		R																						
Reserved	37		R																						
Reserved	38		R																						
Reserved	39		R																						
Reserved	40		R																						



8.10 REMOTE AND AUTO START FEATURE CONFIGURATION

- A.** The CG Series control instrument is designed to require a manual restart should an interruption in power occur.
- B.** The On/off button is a momentary switch. Some users require that the unit must start automatically after an interruption in power or must be started from a remote, customer supplied on/off signal. The CG Series control instrument can be configured in this manner by following the instructions below. The unit may be configured this way by the factory if the unit is ordered with this option or it can be configured in the field.
- C. Factory installed remote or auto start feature:**
1. If CG Series control instrument has been factory configured with the remote or auto start feature the standard on/off buttons will no longer function. A separate on/off switch has been added to the unit.
 2. Use this switch to turn the unit on and off. When in the on position, any time power is applied the unit will start. Models with compressors that include a compressor control module (generally 15 horsepower and larger) also include a factory installed time delay relay of 20 seconds or longer to avoid a compressor module fault on start-up.
- D. Field installed remote or auto start feature:**
1. The factory recommends a manual on/off operator be added to the unit for local control.
 2. Install operator and wire to terminals on back of controller (see picture).
 3. **Note:** operator should be on the on position to utilize remote start/stop. Models with compressors that include a compressor control module (generally 15 horsepower and larger) also require the addition of time delay relay of 20 seconds or longer to avoid a compressor module fault on start-up.
- E.** To active the Remote Start features :
1. Access main menu and advance to the Options menu.
 2. From the Options menu, select Remote Start.
 3. Press the Select button to advantage to the Enabled/Disable screen.
 4. Select Enabled to enable the Remote Start.
 5. Press the Select button to acknowledge and save the selection.



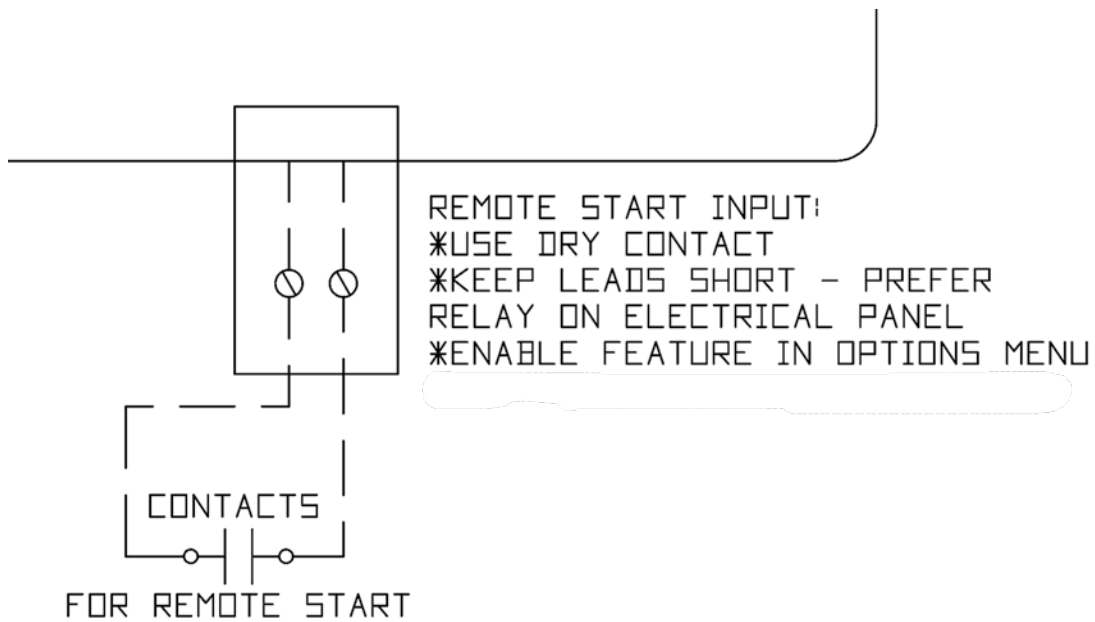

END

© 2021 Temptek, Inc.

RE 20210812